

The background features a blue gradient with several glowing blue spheres of varying sizes. Some spheres are positioned as if on orbital paths, with faint white lines representing these paths. The overall aesthetic is clean, modern, and technical.

TOK BEARING CO., LTD.

**A WORLD LEADER IN
MECHANICAL AND
MOTION TECHNOLOGIES**

**PRODUCT
LINEUP
CATALOG**

INDEX

RoHS compliance
(ALL products)

D-SERIES BEARINGS							Page	
DR - A	Type	1	2	3	4	5	3	
DR - B	Type	6					4	
DR - B	Type	7	8				5	
DR - H	Type	9	10	11	12	13	6	
DO - A B H	Type	1	2	3	4	5	6	7
DU - A B H	Type	1	2	3	4		8	
DV - A B H	Type	1	2	3	4	5		9
DF - B H	Type	1	2	3			10	
DH - A B H	Type	1	2	3			10	

D-SERIES ROLLERS			Page	
DL - A B	Type	1	2	11

I-SERIES BEARINGS					Page		
IDS - A B H	Type	1	2	3	4	12	
IN - A B	Type	1	2	3		13	
ID - A B	Type	1	2	3	4	5	13

A-SERIES BEARINGS							Page		
A - A B H	Type	1	2	3	4	5	6	7	14

TPF/THF-SERIES BEARINGS				Page	
TPF	Dimension	TPF-613ZZ-5		TPF-816ZZ-5	16
THF	Dimension	THF-612ZZ-4.5		THF-816ZZ-5	17



Telefon +41 81 300 40 00
Telefax +41 81 300 40 09



www.mtoswiss.ch
info@mtoswiss.ch



Plastic bearings with a multitude configurations and materials that can suit any customer demand

BEARING PART NUMBER NOMENCLATURE AND DESCRIPTIONS

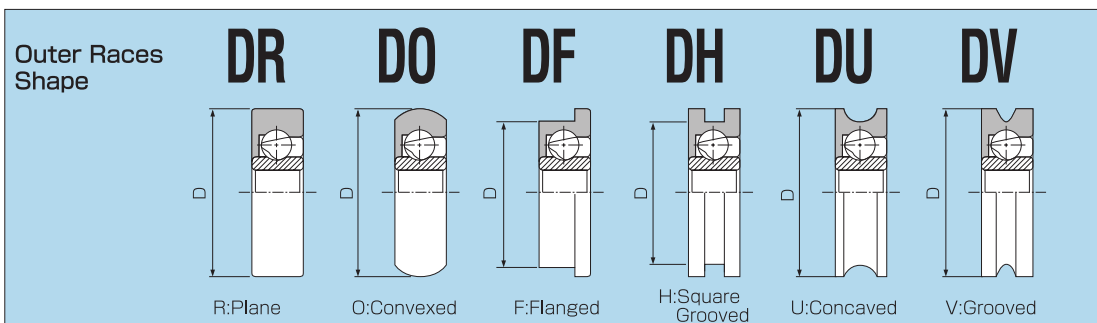

Index number of outer races diameter

In most cases, this number reflects the overall diameter of the bearings. Exceptions are : DH-type of bearing with square groove—index number reflects the "bottom-to-bottom" diameter ; DF—type with flanged shape—index number reflects each diameter of the race threads.

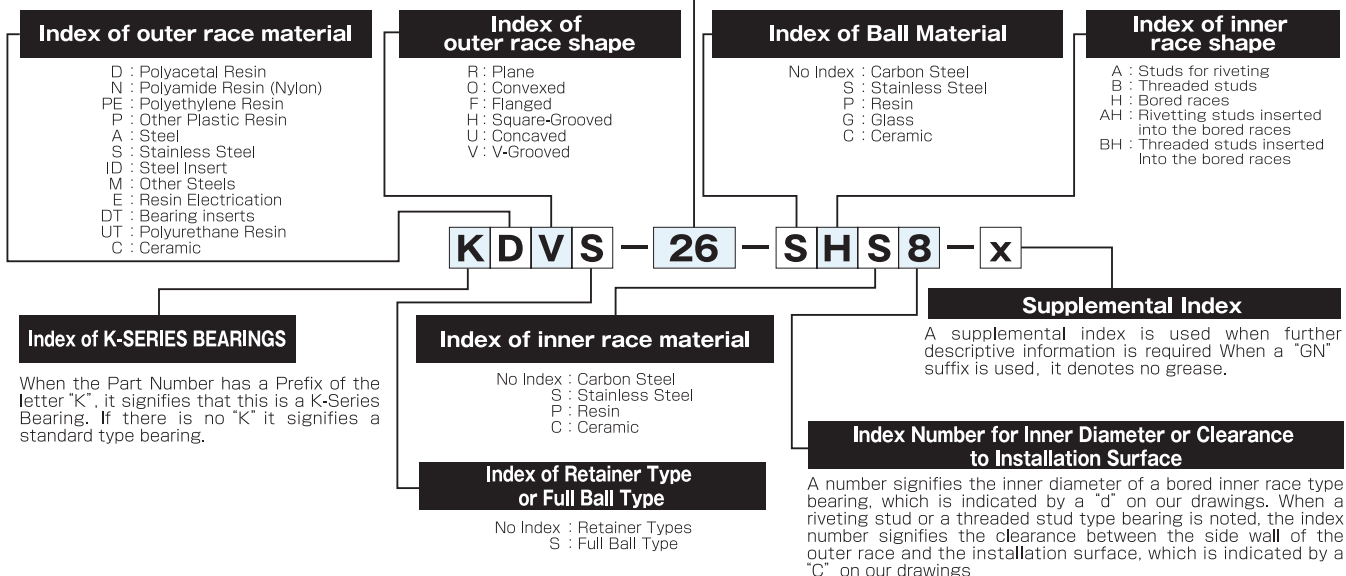

DR-A

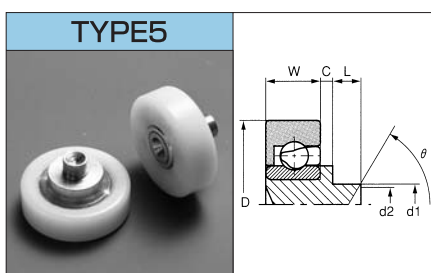
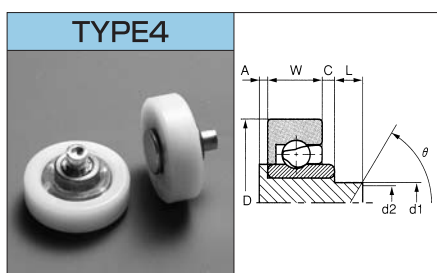
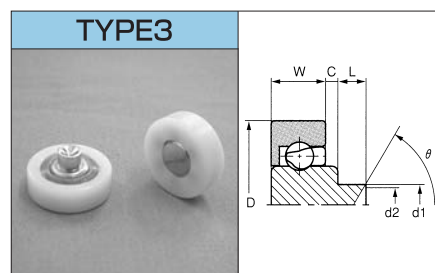
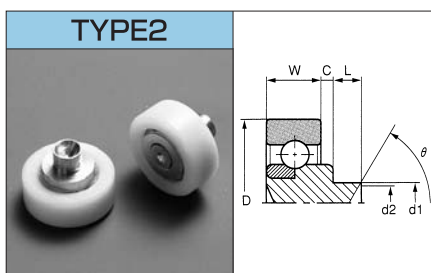
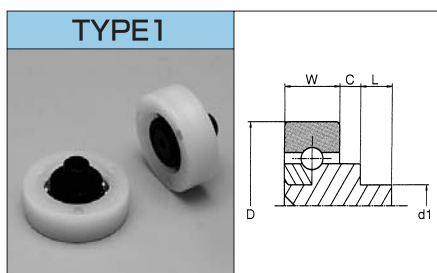

Code	Part No.	D _{-0.1} [mm]	d1 _{-0.1} [mm]	W _{-0.2} [mm]	C ^{±0.4} [mm]	L ^{±0.2} [mm]	(d2 × θ) ^{*1}	A ^{±0.2} [mm]	Load ^{*2} [N] (kgf)	Type	Q'ty [pcs/box]	Gross Weight [kg/box]
000006	DRS-9-A0.5	9 _{-0.05}	2 _{-0.05}	3 _{-0.1}	0.5	1.8	—	—	[9.8] (1)	1	10,000	—
000007	DRS-12-A0.5	12 _{-0.05}	3 _{-0.05}	4 ^{±0.1}	0.5 ^{±0.3}	2.3	—	—	[9.8] (1)	1	10,000	—
000001	DRS-16-A1	16 _{-0.3}	4	5 ^{±0.2}	1	3.5	φ3 × 100°	—	19.6 (2)	2	2,000	9.0
000003	DRS-16-A1.5	16 _{-0.3}	5	6.35 ^{±0.2}	1.5	3.5	φ4.5 × 90°	—	19.6 (2)	2	2,500	14.4
000100	DR-18-A0.5	18	5	6	0.5	3.5	φ4 × 120°	—	19.6 (2)	3	2,000	9.6
000200	DR-19-A0.5	19	5	6	0.5	3.5	φ4 × 120°	—	29.4 (3)	3	2,000	10.7
000207	DR-19-A2	19	5	6	2	3.5	φ4.4 × 120°	—	29.4 (3)	3	2,000	11.6
000408	DR-22-A-2.1	22	5	7	0	2.1	φ4 × 90°	—	78.4 (8)	3	1,000	7.4
000400	DR-22-A1	22	5	7	1	3.5	φ4.4 × 90°	—	78.4 (8)	3	1,000	9.0
000410	DR-22-A2-φ6	22	6	7	2	3.5	φ5.5 × 90°	—	78.4 (8)	3	1,000	9.4
000411	DR-22-A2	22	5	7	2	3.5	φ4 × 90°	—	78.4 (8)	3	1,000	8.9
000600	DR-24-A1	24	5	7	1	3.5	φ4.4 × 90°	—	78.4 (8)	3	1,000	9.5
000700	DR-26-A1	26	5	7	1	3.5	φ4.4 × 90°	—	78.4 (8)	3	1,000	10.2
000800	DR-28-A1	28	5	7	1	3.5	φ4.4 × 90°	—	78.4 (8)	3	500	5.8
000900	DR-29-A1	29	5	7	1	3.5	φ4.4 × 90°	—	78.4 (8)	3	500	5.7
000427	DR-22-AH(1) 3.5-8019	22	4.5 ^{±0.1}	7	0	3.5 ^{+0.3}	nothing	1	196 (20)	4	1,000	9.1
000419	DR-22-AH2.5-3.65	22	4.5 ^{±0.1}	7	2.5	3.65	φ2.5 × 100°	1	196 (20)	4	1,000	10.2
000705	DR-26-AH	26	4.5 ^{±0.1}	7	0	3.5 ^{+0.3}	nothing	1 ^{±0.3}	196 (20)	4	1,000	10.2
000707	DR-26-AH2.5-3.65	26	4.5 ^{±0.1}	7	2.5	3.65	φ2.5 × 100°	1	196 (20)	4	800	8.8
040707	DR-26-AH2.7-2.7	26	3.9 _{-0.2}	7	2.7	2.7	φ2.3 × 110°	1 ^{±0.3}	196 (20)	4	800	8.8
040706	DR-26-AH2.7-4	26	3.9 _{-0.2}	7	2.7	4 ^{±0.3}	φ2.7 × 120°	1 ^{±0.3}	196 (20)	4	800	9.8
000414	DR-22-AH2.5	22	5	7	2.5	3.5	φ4 × 110°	—	196 (20)	5	1,000	10.0
000416	DR-22-AH3.8-2.5	22	4.9	7	3.8	2.5	nothing	—	196 (20)	5	1,000	10.6
000417	DR-22-AH4	22	5	7	4	3.5	φ4 × 110°	—	196 (20)	5	1,000	10.8
000706	DR-26-AH4	26	5	7	4	3.5	φ4 × 110°	—	196 (20)	5	800	9.8

*1 Reference Dimension

*2 Allowable Load at 300min -1 (300r.p.m.)

Size limits can be modified for practical applications. Please contact our sales/engineering departments for further information and assistance.

DR-B

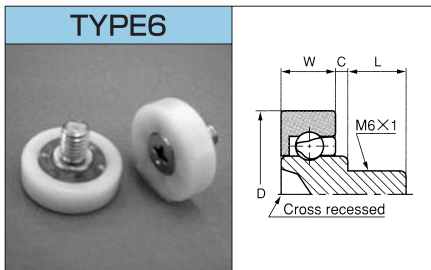

Code	Part No.	$D_{-0.1}$ [mm]	$W_{-0.2}$ [mm]	$C_{\pm 0.4}$ [mm]	$L_{\pm 0.5}$ [mm]	Load *1 [N] (kgf)	Type	Q'ty [pcs/box]	Gross Weight [kg/box]
020200	DR-19-B0.5	19	6	0.5	8	49 (5)	6	2,000	12.5
020207	DR-19-B1-14	19	6	1	14	49 (5)	6	1,500	11.1
020208	DR-19-B1.5	19	6	1.5	8	49 (5)	6	2,000	12.9
020212	DR-19-B3.5	19	6	3.5	8	49 (5)	6	1,500	11.0
020404	DR-22-B0.5-4.5	22	7	0.5	4.5	196 (20)	6	1,000	8.4
020400	DR-22-B0.5	22	7	0.5	8	196 (20)	6	1,000	9.8
020408	DR-22-B1-10	22	7	1	10	196 (20)	6	1,000	9.5
020428	DR-22-B3-10.5	22	7	3	10.5	196 (20)	6	1,000	11.5
020427	DR-22-B3.6-12.4	22	7	3.6	12.4	196 (20)	6	1,000	10.9
020415	DR-22-B3.6-14.5	22	7	3.6	14.5	196 (20)	6	1,000	11.9
020600	DR-24-B0.5	24	7	0.5	8	196 (20)	6	1,000	10.4
020608	DR-24-B3-10.5	24	7	3	10.5	196 (20)	6	1,000	11.7
020702	DR-26-B0.5-4.5	26	7	0.5	4.5	196 (20)	6	1,000	9.7
020700	DR-26-B0.5	26	7	0.5	8	196 (20)	6	1,000	10.1
020720	DR-26-B3-10.5	26	7	3	10.5	196 (20)	6	800	10.7
020719	DR-26-B3.6-12.4	26	7	3.6	12.4	196 (20)	6	800	11.3
020714	DR-26-B5-11	26	7	5	11	196 (20)	6	800	8.8
020800	DR-28-B0.5	28	7	0.5	8	196 (20)	6	500	6.7
020803	DR-28-B2-15	28	7	2	15	196 (20)	6	500	6.7
020805	DR-28-B3-10.5	28	7	3	10.5	196 (20)	6	500	6.9
021000	DR-30-B0.5	30	7	0.5	8	196 (20)	6	500	6.8
021005	DR-30-B3-10.5	30	7	3	10.5	196 (20)	6	500	7.6
021004	DR-30-B3.6-12.4	30	7	3.6	12.4	196 (20)	6	500	12.5

*1 Allowable Load at 300min -1 (300r.p.m.)

Size limits can be modified for practical applications. Please contact our sales/engineering departments for further information and assistance.

DR-B

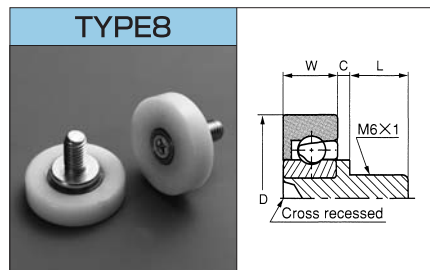
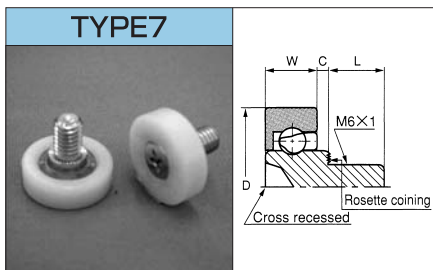

Code	Part No.	D _{-0.1} [mm]	W _{-0.2} [mm]	C ^{±0.4} [mm]	L ^{±0.5} [mm]	Load ^{*1} [N] (kgf)	Type	Q'ty [pcs/box]	Gross Weight [kg/box]
020205	DR-19-B1-5.5	19	6	1	5.5	49 (5)	7	2,000	11.5
020204	DR-19-B1	19	6	1	8	49 (5)	7	2,000	13.5
020210	DR-19-B2-4.5	19	6	2	4.5	49 (5)	7	2,000	12.1
020209	DR-19-B2	19	6	2	8	49 (5)	7	2,000	14.0
020211	DR-19-B2.7	19	6	2.7	8	49 (5)	7	1,500	10.2
020214	DR-19-B3	19	6	3	8	49 (5)	7	1,500	10.7
020406	DR-22-B1	22	7	1	8	196 (20)	7	1,000	9.0
020411	DR-22-B2-5.5	22	7	2	5.5	196 (20)	7	1,000	9.3
020409	DR-22-B2	22	7	2	8	196 (20)	7	1,000	10.3
020413	DR-22-B3	22	7	3	8	196 (20)	7	1,000	11.3
020418	DR-22-B4-4.5	22	7	4	4.5	196 (20)	7	1,000	10.3
020416	DR-22-B4	22	7	4	8	196 (20)	7	1,000	11.7
020420	DR-22-B5	22	7	5	8	196 (20)	7	1,000	12.3
020422	DR-22-B6	22	7	6	8	196 (20)	7	1,000	12.8
020602	DR-24-B2	24	7	2	8	196 (20)	7	1,000	11.4
020604	DR-24-B3	24	7	3	8	196 (20)	7	1,000	11.7
020605	DR-24-B4	24	7	4	8	196 (20)	7	1,000	12.4
020606	DR-24-B5	24	7	5	8	196 (20)	7	1,000	12.5
020607	DR-24-B6	24	7	6	8	196 (20)	7	1,000	13.3
020705	DR-26-B2	26	7	2	8	196 (20)	7	800	9.2
020707	DR-26-B3	26	7	3	8	196 (20)	7	800	9.7
020710	DR-26-B4	26	7	4	8	196 (20)	7	800	10.1
020716	DR-26-B6-6	26	7	6	6	196 (20)	7	800	10.7
020715	DR-26-B6	26	7	6	8	196 (20)	7	800	11.1
020801	DR-28-B2	28	7	2	8	196 (20)	7	500	6.7
021002	DR-30-B3	30	7	3	8	196 (20)	7	500	11.3
020429	DR-22-BH2-11	22	7	2	11	196 (20)	8	1,000	12.3
020430	DR-22-BH3-11	22	7	3	11	196 (20)	8	1,000	11.4
020722	DR-26-BH2-11	26	7	2	11	196 (20)	8	800	10.6
020804	DR-28-BH2-11	28	7	2	11	196 (20)	8	500	6.9

*1 Allowable Load at 300min⁻¹ (300r.p.m.)

Size limits can be modified for practical applications. Please contact our sales/engineering departments for further information and assistance.

DR-H

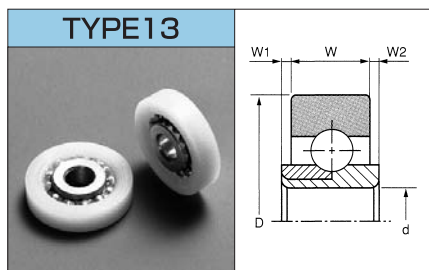
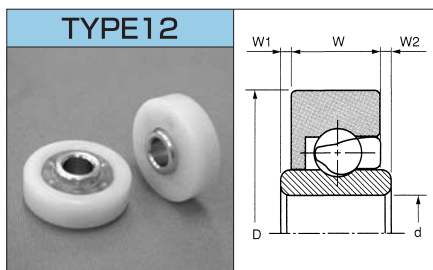
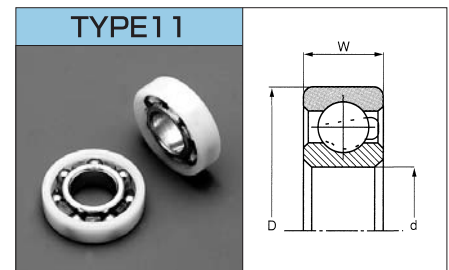
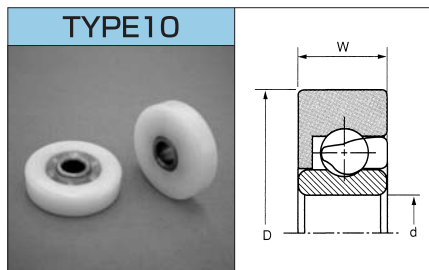
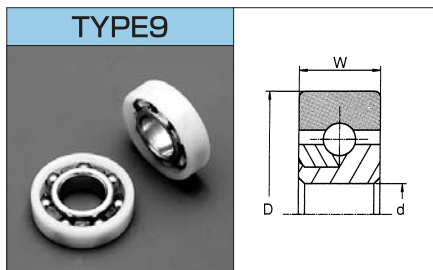

Code	Part No.	D _{-0.1} [mm]	d ₀ ^{+0.1} [mm]	W _{-0.2} [mm]	W1*1 [mm]	W2*1 [mm]	Load*2 [N] (kgf)	Type	Q'ty [pcs/box]	Gross Weight [kg/box]
040012	DRS-9-H2.5	9 _{-0.05}	2.5 ₀ ^{+0.05}	3 ^{±0.1}	—	—	9.8 (1)	9	10,000	—
040013	DRS-12-H3	12 _{-0.05}	3 ₀ ^{+0.05}	4 ^{±0.1}	—	—	9.8 (1)	9	10,000	—
040100	DR-18-H6	18	6	6	—	—	49 (5)	10	2,500	7.6
040202	DR-19-H5	19	5	6	—	—	49 (5)	10	2,500	8.9
040205	DR-19-H6	19	6	6	—	—	49 (5)	10	2,500	8.1
040301	DR-20-H8	20	8	6 ^{±0.1}	—	—	29.4 (3)	10	1,500	6.1
040401	DR-22-H6	22	6	7	—	—	196 (20)	10	1,500	9.5
040412	DR-22-H8	22	8	7	—	—	49 (5)	10	1,500	8.2
040600	DR-24-H6	24	6	7	—	—	196 (20)	10	1,000	7.1
040602	DR-24-H10.5	24	10.5	7	—	—	49 (5)	10	1,000	11.5
040701	DR-26-H6	26	6	7	—	—	196 (20)	10	1,000	7.8
041600	DR-26-H10	26	10	8	—	—	196 (20)	10	1,000	7.9
040800	DR-28-H6	28	6	7	—	—	196 (20)	10	500	4.2
041000	DR-30-H6	30	6	7	—	—	196 (20)	10	500	5.6
041610	DR-30-H10-9	30	10	9	—	—	245 (25)	10	500	7.7
041005	DR-30-H10-8	30	10	8 ^{±0.1}	—	—	245 (25)	10	500	6.7
041612	DR-32-H12	32	12	10	—	—	294 (30)	10	500	9.6
041100	DR-35-H6	35	6	7	—	—	196 (20)	10	500	5.7
041614	DR-35-H15	35	15	11 ^{±0.2}	—	—	294 (30)	10	400	10.6
041151	DR-38-H10	38	10	8 ^{±0.2}	—	—	196 (20)	10	500	6.1
041200	DR-40-H6	40 _{-0.2}	6	8	—	—	196 (20)	10	400	5.4
041616	DR-40-H17	40	17	12 ^{±0.2}	—	—	294 (30)	10	250	6.9
041618	DR-47-H20	47	20	14	—	—	343 (35)	10	150	8.7
040102	DR-18-H8	18	8	5	—	—	49 (5)	11	3,000	8.7
040007	DR-16-H4.1W0.25	16	4.1	4	0.25	0.25	19.6 (2)	12	4,000	9.6
040200	DR-19-H4W (1.3) 3	19	4	6	1.3	3	49 (5)	12	1,500	8.2
040204	DR-19-H5W (0) 2.3	19	5	6	0	2.3	49 (5)	12	2,000	8.6
040400	DR-22-H4W (0.5) 3	22	4	7	0.5	3	196 (20)	12	1,000	8.3
040415	DR-22-H6W1	22	6	7	1	1	196 (20)	12	1,000	6.6
040601	DR-24-H6W1	24	6	7	1	1	196 (20)	12	1,000	7.3
040700	DR-26-H4W (0.5) 3	26	4	7	0.5	3	196 (20)	12	1,000	9.7
040704	DR-26-H6W1	26	6	7	1	1	196 (20)	12	1,000	8.8
040802	DR-28-H6W1	28	6	7	1	1	196 (20)	12	500	4.5
041003	DR-30-H6W1	30	6	7	1	1	196 (20)	12	500	6.4
041101	DR-35-H6W1	35	6	7	1	1	196 (20)	12	500	6.8
041201	DR-40-H6W0.5	40 _{-0.2}	6	8	0.5	0.5	196 (20)	12	400	5.5
041300	DR-47-H8W (0) 9	47	8	14	0	9	196 (20)	12	100	3.5
040005	DRS-16-H4.1W0.25	16	4.1	3.5 ^{±0.2}	0.25	0.25	49 (5)	13	5,000	11.0

*1 Reference Dimension

*2 Allowable Load at 300min -1 (300r.p.m.)

Size limits can be modified for practical applications. Please contact our sales/engineering departments for further information and assistance.

MTO & Co. AG

Tel: +41 81 300 40 00 www.mtoswiss.ch

Fax: +41 81 300 40 09 info@mtoswiss.ch

DO

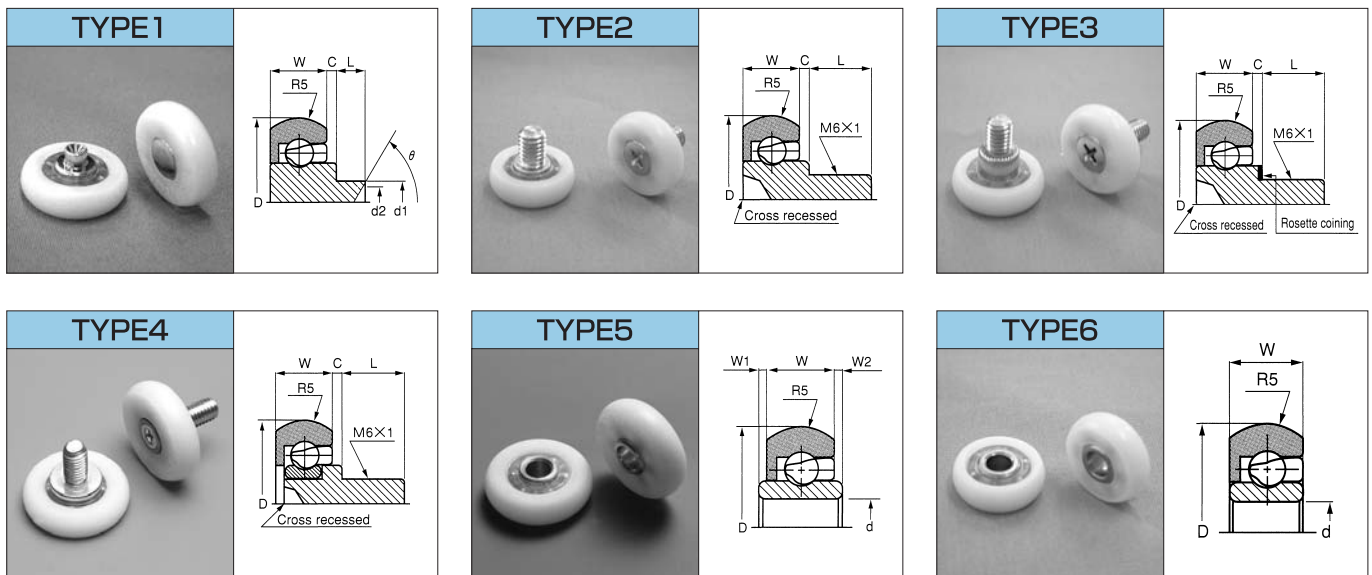

Code	Part No.	D _{-0.2} [mm]	d _{0.1} ⁺ [mm]	d1 _{-0.1} [mm]	W _{-0.2} [mm]	C ^{±0.4} [mm]	L ^{±0.2} [mm]	(d2 × θ) ^{*1}	W1 ^{*1} [mm]	W2 ^{*1} [mm]	Load ^{*2} [N] (kgf)	Type	Q'ty [pcs/box]	Gross Weight [kg/box]
070010	DO-19-A0.5	19	—	5	6	0.5	3.5	φ4 × 120°	—	—	29.4 (3)	1	2,000	10.8
070020	DO-22-A1	22	—	5	7	1	3.5	φ4.4 × 90°	—	—	78.4 (8)	1	1,000	8.9
070021	DO-22-A3	22	—	5	7	3	3.5	φ4 × 90°	—	—	78.4 (8)	1	1,000	9.3
070030	DO-24-A1	24	—	5	7	1	3.5	φ4.4 × 90°	—	—	78.4 (8)	1	1,000	9.8
070040	DO-26-A1	26	—	5	7	1	3.5	φ4.4 × 90°	—	—	78.4 (8)	1	1,000	10.3
071010	DO-19-B0.5	19	—	—	6	0.5	8 ^{±0.5}	—	—	—	49 (5)	2	2,000	12.5
071012	DO-19-B0.5-4.5	19	—	—	6	0.5	4.5 ^{±0.5}	—	—	—	49 (5)	2	2,000	10.3
071020	DO-22-B0.5	22	—	—	7	0.5	8 ^{±0.5}	—	—	—	196 (20)	2	1,000	9.3
071026	DO-22-B3-10.5	22	—	—	7	3	10.5 ^{±0.5}	—	—	—	196 (20)	2	1,000	10.4
071030	DO-24-B0.5	24	—	—	7	0.5	8 ^{±0.5}	—	—	—	196 (20)	2	1,000	10.3
071040	DO-26-B0.5	26	—	—	7	0.5	8 ^{±0.5}	—	—	—	196 (20)	2	1,000	10.7
071050	DO-28-B0.5	28	—	—	7	0.5	8 ^{±0.5}	—	—	—	196 (20)	2	500	6.3
071023	DO-22-B5	22	—	—	7	5	8 ^{±0.5}	—	—	—	196 (20)	3	1,000	11.2
071031	DO-24-B2	24	—	—	7	2	8 ^{±0.5}	—	—	—	196 (20)	3	1,000	10.8
071032	DO-24-B3	24	—	—	7	3	8 ^{±0.5}	—	—	—	196 (20)	3	1,000	11.8
071034	DO-24-B4	24	—	—	7	4	8 ^{±0.5}	—	—	—	196 (20)	3	1,000	11.6
071060	DO-30-B3	30	—	—	7	3	8 ^{±0.5}	—	—	—	196 (20)	3	500	6.4
071035	DO-24-BH0.5	24	—	—	7	0.5	8 ^{±0.5}	—	—	—	196 (20)	4	1,000	8.8
071045	DO-26-BH2-11	26	—	—	7	2	11 ^{±0.5}	—	—	—	196 (20)	4	800	10.1
072031	DO-24-H6W1	24	6	—	7	—	—	—	1	1	196 (20)	5	1,000	7.8
072043	DO-26-H6W1	26	6	—	7	—	—	—	1	1	196 (20)	5	1,000	8.5
072072	DO-35-H6W1	35	6	—	7	—	—	—	1	1	196 (20)	5	500	5.1
072080	DO-40-H6W0.5	40	6	—	8 _{-0.3}	—	—	—	0.5	0.5	196 (20)	5	400	4.5
072000	DO-18-H5	18	5	—	6	—	—	—	—	—	49 (5)	6	2,500	8.1
072010	DO-19-H5	19	5	—	6	—	—	—	—	—	49 (5)	6	2,500	9.8
072020	DO-22-H6	22	6	—	7	—	—	—	—	—	196 (20)	6	1,500	8.9
072030	DO-24-H6	24	6	—	7	—	—	—	—	—	196 (20)	6	1,000	7.3
072040	DO-26-H6	26	6	—	7	—	—	—	—	—	196 (20)	6	1,000	8.0
072050	DO-28-H6	28	6	—	7	—	—	—	—	—	196 (20)	6	800	8.7
072060	DO-29-H6	29	6	—	7 _{-0.1}	—	—	—	—	—	196 (20)	6	500	4.0

*1 Reference Dimension

*2 Allowable Load at 300min⁻¹ (300r.p.m.)

Size limits can be modified for practical applications. Please contact our sales/engineering departments for further information and assistance.

DU

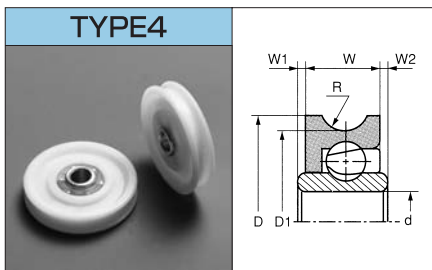
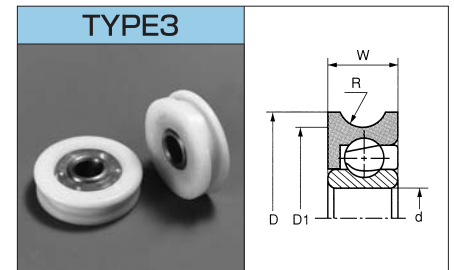
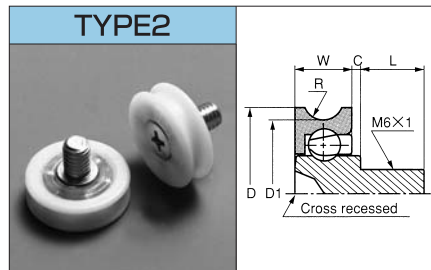
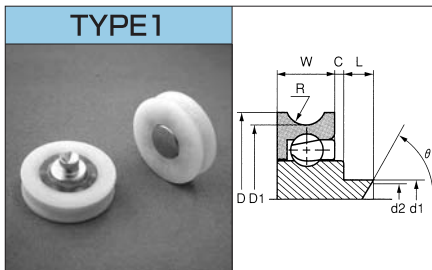

Code	Part No.	D ^{±0.2} [mm]	D1 ^{±0.1} [mm]	d ^{+0.1} [mm]	d1 ^{-0.1} [mm]	W ^{-0.2} [mm]	C ^{±0.4} [mm]	L ^{±0.2} [mm]	^{*1} (d2 × θ)	W1 ^{*1} [mm]	W2 ^{*1} [mm]	R	Load ^{*2} [N] (kgf)	Type	Q'ty [pcs/box]	Gross Weight [kg/box]
080010	DU-19-A0.5	19	17	—	5	6	0.5	3.5	φ4 × 120°	—	—	1.75	29.4 (3)	1	2,000	10.3
080020	DU-22-A1	22	19.2	—	5	7	1	3.5	φ4.4 × 90°	—	—	2.5	58.8 (6)	1	1,000	8.5
080030	DU-24-A1	24	21.2	—	5	7	1	3.5	φ4.4 × 90°	—	—	2.5	58.8 (6)	1	1,000	9.3
080040	DU-26-A1	26	23.2	—	5	7	1	3.5	φ4.4 × 90°	—	—	2.5	58.8 (6)	1	1,000	10.3
081010	DU-19-B0.5	19	17	—	—	6	0.5	8 ^{±0.5}	—	—	—	1.75	39.2 (4)	2	2,000	12.4
081013	DU-19-B2	19	17	—	—	6	2	8 ^{±0.5}	—	—	—	1.75	39.2 (4)	2	2,000	12.8
081020	DU-22-B0.5	22	19.2	—	—	7	0.5	8 ^{±0.5}	—	—	—	2.5	156 (16)	2	1,000	9.8
081021	DU-22-B6	22	19.2	—	—	7	6	8 ^{±0.5}	—	—	—	2.5	156 (16)	2	1,000	11.8
081030	DU-24-B0.5	24	21.2	—	—	7	0.5	8 ^{±0.5}	—	—	—	2.5	156 (16)	2	1,000	10.5
081040	DU-26-B0.5	26	23.2	—	—	7	0.5	8 ^{±0.5}	—	—	—	2.5	156 (16)	2	1,000	11.3
082010	DU-19-H5	19	17	5	—	6	—	—	—	—	—	1.75	39.2 (4)	3	2,500	9.8
082020	DU-22-H6	22	19.2	6	—	7	—	—	—	—	—	2.5	156 (16)	3	1,500	8.8
082060	DU-24-H6	24	21.2	6	—	7	—	—	—	—	—	2.5	156 (16)	3	1,000	6.7
082070	DU-26-H6	26	23.2	6	—	7	—	—	—	—	—	2.5	156 (16)	3	1,000	7.4
082100	DU-30-H6-M	30	25.7	6	—	7 ^{±0.2}	—	—	—	—	—	2.5	156 (16)	3	500	3.6
082101	DU-30-H10	30	26	10	—	8 ^{±0.2}	—	—	—	—	—	2.5	196 (20)	3	500	6.1
082031	DU-22-H6W0.5	22	19	6	—	7	—	—	—	0.5	0.5	2.5	156 (16)	4	1,500	5.8
082028	DU-22-H6W1	22	19.2	6	—	7	—	—	—	1	1	2.5	156 (16)	4	1,000	6.2
082090	DU-28-H6W1	28	24	6	—	7	—	—	—	1	1	2.5	156 (16)	4	800	8.0
082103	DU-30-H6W1	30	25.7	6	—	7	—	—	—	1	1	2.5	156 (16)	4	500	6.1
082110	DU-35-H6W1	35	31	6	—	7	—	—	—	1	1	2.5	156 (16)	4	500	5.8
082120	DU-40-H6W0.5	40	36	6	—	8 ^{±0.2}	—	—	—	0.5	0.5	2.5	156 (16)	4	400	5.4

*1 Reference Dimension

*2 Allowable Load at 300min -1 (300r.p.m.)

Size limits can be modified for practical applications. Please contact our sales/engineering departments for further information and assistance.

DV

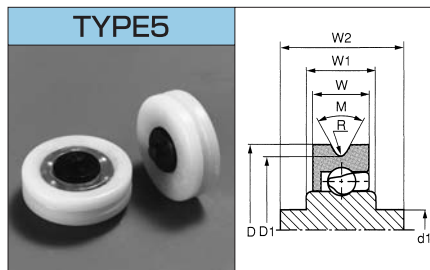
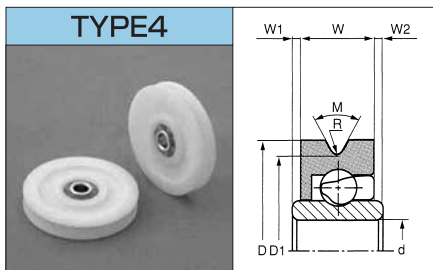
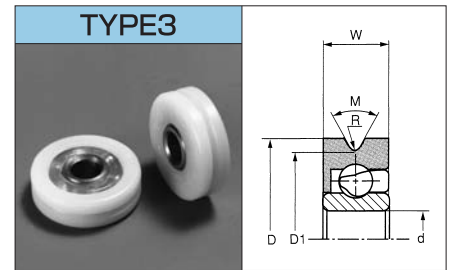
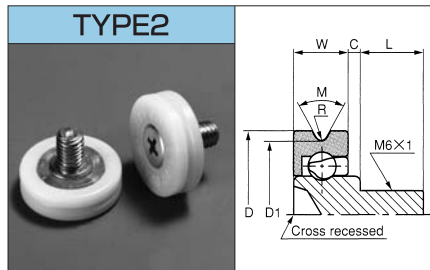
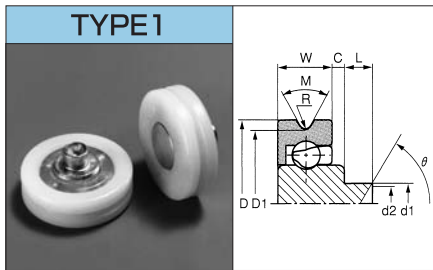

Code	Part No.	D ^{±0.2} [mm]	D1 ^{±0.2} [mm]	d ^{+0.1} ₀ [mm]	d1 ^{-0.1} [mm]	W ^{-0.2} [mm]	C ^{±0.4} [mm]	L ^{±0.2} [mm]	*1 (d2 × θ)	W1 ^{*1} [mm]	W2 ^{*1} [mm]	M°	R	Type	Q'ty [pcs/box]	Gross Weight [kg/box]
090000	DV-19-A0.5	19	17	—	5	6	0.5	3.5	φ4 × 120°	—	—	60	0.6	1	2,000	11.0
090100	DV-22-A1	22	19	—	5	7	1	3.5	φ4.4 × 90°	—	—	60	0.6	1	1,000	9.2
090200	DV-24-A1	24	21	—	5	7	1	3.5	φ4.4 × 90°	—	—	60	0.6	1	1,000	9.8
090300	DV-26-A1	26	23	—	5	7	1	3.5	φ4.4 × 90°	—	—	60	0.6	1	1,000	10.6
090400	DV-28-A1	28	24	—	5	7	1	3.5	φ4.4 × 90°	—	—	(58)	0.6	1	500	5.3
090500	DV-30-A1	30	27	—	5	7	1	3.5	φ4.4 × 90°	—	—	60	0.6	1	500	6.5
090600	DV-38-A0.5	38	35	—	5	8 ^{±0.2}	0.5	3.5	φ4.4 × 90°	—	—	60	0.6	1	500	7.5
091000	DV-19-B0.5	19	17	—	—	6	0.5	8 ^{±0.5}	—	—	—	60	0.6	2	2,000	12.6
091100	DV-22-B0.5	22	19	—	—	7	0.5	8 ^{±0.5}	—	—	—	60	0.6	2	1,000	10.0
091200	DV-24-B0.5	24	21	—	—	7	0.5	8 ^{±0.5}	—	—	—	60	0.6	2	1,000	10.6
091201	DV-24-B3	24	21	—	—	7	3	8 ^{±0.5}	—	—	—	60	0.6	2	1,000	10.7
091300	DV-26-B0.5	26	23	—	—	7	0.5	8 ^{±0.5}	—	—	—	60	0.6	2	1,000	11.2
091500	DV-30-B0.5-0.5R	30	28	—	—	7	0.5	8 ^{±0.5}	—	—	—	90	0.5	2	500	8.0
091501	DV-32.5-B1.5-2R	32.5	20.5	—	—	9.5 ^{±0.2}	1.5	8 ^{±0.5}	—	—	—	15	2	2	400	6.6
091600	DV-38-B0.5	38	35	—	—	8 ^{±0.2}	0.5	8 ^{±0.5}	—	—	—	60	0.6	2	250	5.8
092001	DV-19-H5	19	17	5	—	6	—	—	—	—	—	60	0.6	3	2,500	10.0
092100	DV-22-H6-M	22	19	6	—	7	—	—	—	—	—	60	0.6	3	1,500	9.7
092200	DV-24-H6	24	21	6	—	7	—	—	—	—	—	60	0.6	3	1,000	7.4
092201	DV-24-H8	24	20 ^{±1}	8	—	7	—	—	—	—	—	30	0.6	3	1,000	5.6
092300	DV-26-H6	26	23	6	—	7	—	—	—	—	—	60	0.6	3	1,000	8.0
092500	DV-30-H6	30	27	6	—	7	—	—	—	—	—	60	0.6	3	500	6.8
092700	DV-48-H6W0.4-1.6R	48.3	35	6	—	8.2 ^{±0.2}	—	—	—	0.4	0.4	30	1.6	4	250	4.1
090102	DV-22-AW0.5-B	22 ^{-0.1}	19 ^{±0.1}	—	3	7	—	—	—	8	12	60	0.65	5	1,000	8.9

***1 Reference Dimension**

Size limits can be modified for practical applications. Please contact our sales/engineering departments for further information and assistance. These products are made to order.

DF

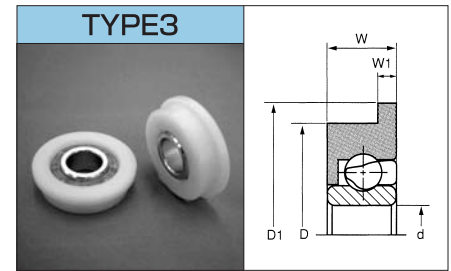
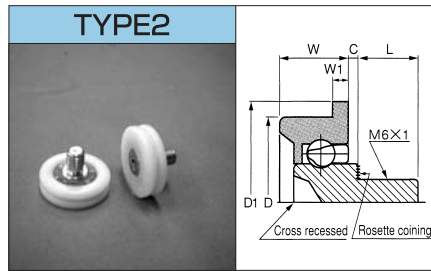
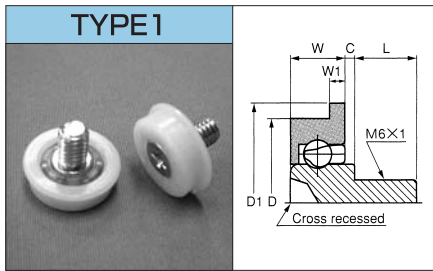

Code	Part No.	D _{-0.1} [mm]	D1 ^{±0.2} [mm]	d ^{+0.1} [mm]	W _{-0.2} [mm]	W1 ^{±0.2} [mm]	C ^{±0.4} [mm]	L ^{±0.5} [mm]	Load *1 [N] (kgf)	Load *2 [N] (kgf)	Type	Q'ty [pcs/box]	Gross Weight [kg/box]
061001	DF-17-B0.5	17	19	—	6	1	0.5	8	49 (5)	—	1	1,500	10.0
061020	DF-22-B0.5	22	26	—	7	2	0.5	8	196 (20)	—	1	1,000	9.4
061040	DF-26-B1	26 ^{±0.2}	32	—	11 ^{±0.2}	3	1	8	196 (20)	—	2	400	5.3
061043	DF-26-B2	26 ^{±0.2}	32	—	11 ^{±0.2}	3	2	8	196 (20)	—	2	400	5.8
062000	DF-17-H6	17	19 ^{±0.1}	6	6	1 ^{±0.1}	—	—	49 (5)	14.7 (1.5)	3	3,000	9.5
062005	DF-19-H6	19	22	6	7	1.5	—	—	147 (15)	29.4 (3)	3	1,500	7.7
062020	DF-22-H6	22	26	6	7	2	—	—	196 (20)	39.2 (4)	3	1,500	9.5
062027	DF-23-H10	23	24.75	10	8 ^{±0.2}	1.5 ^{±0.1}	—	—	98 (10)	39.2 (4)	3	1,000	7.2
062061	DF-30-H10-3	30	34	10	8.5 ^{±0.2}	3	—	—	245 (25)	58.8 (6)	3	500	7.0
062062	DF-32-H12	32	36	12	10	3	—	—	245 (25)	58.8 (6)	3	400	7.5

*1 Allowable Load at 300rpm -1 rotation of outer-race

*2 Allowable Load at 300rpm -1 rotation of inner-race

Size limits can be modified for practical applications. Please contact our sales/engineering departments for further information and assistance.

DH

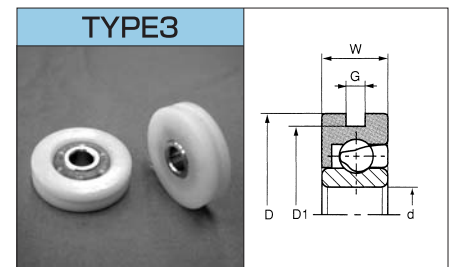
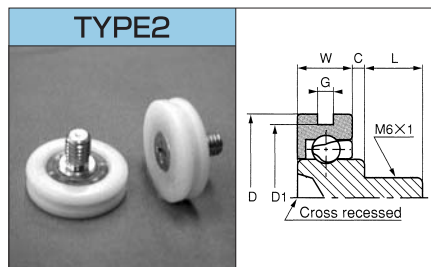
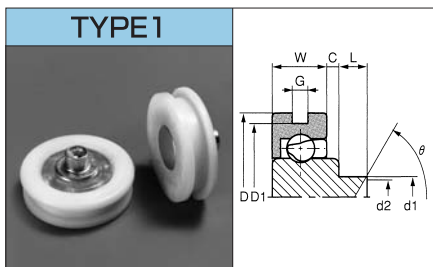

Code	Part No.	D ^{±0.2} [mm]	D1 ^{±0.2} [mm]	d ^{+0.1} [mm]	d1 _{-0.1} [mm]	W _{-0.2} [mm]	C ^{±0.4} [mm]	L ^{±0.2} [mm]	(d2×θ) ^{*1}	G ^{±0.2} [mm]	Type	Q'ty [pcs/box]	Gross Weight [kg/box]
100000	DH-16-A0.5	19	16	—	5	6	0.5	3.5	φ 4×120°	2.1	1	2,000	10.9
101012	DH-16-B0.5	19	16	—	—	6	0.5	8 ^{±0.5}	—	2.1	2	2,000	12.5
101013	DH-16-B1	19	16	—	—	6	1	8 ^{±0.5}	—	2.1	2	2,000	11.8
101020	DH-19-B0.5-2	22	19	—	—	7	0.5	8 ^{±0.5}	—	2	2	1,000	9.9
101040	DH-21-B0.5-2	24	21	—	—	7	0.5	8 ^{±0.5}	—	2	2	1,000	10.5
102010	DH-16-H5	19	16	5	—	6	—	—	—	2.1	3	2,000	9.9
102021	DH-19-H6-2	22	19	6	—	7	—	—	—	2	3	1,000	9.6
102025	DH-19-H6-2.5	22	19	6	—	7	—	—	—	2.5	3	1,500	8.4
102040	DH-21-H6-2	24	21	6	—	7	—	—	—	2	3	1,000	7.3
102041	DH-21-H6-3	24	21	6	—	7	—	—	—	3	3	1,000	6.5
102042	DH-21-H6-3.2	24	21	6	—	7	—	—	—	3.2	3	1,000	6.2

*1 Reference Dimension

Size limits can be modified for practical applications. Please contact our sales/engineering departments for further information and assistance. These products are made to order.

MTO & Co. AG

Tel: +41 81 300 40 00 www.mtoswiss.ch

Fax: +41 81 300 40 09 info@mtoswiss.ch

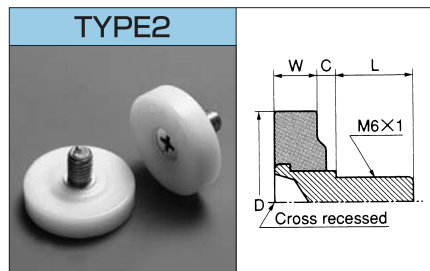
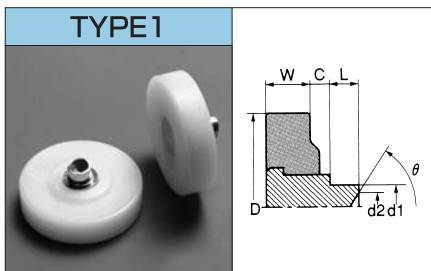

Code	Part No.	D _{-0.1} ⁰ [mm]	d1 _{-0.1} ⁰ [mm]	W _{-0.2} ⁰ [mm]	C ^{±0.4} [mm]	L ^{±0.2} [mm]	(d2 × θ) ^{*1}	Type	Q'ty [pcs/box]	Gross Weight [kg/box]
240012	DL-16-A0.5	16	4	5	0.5	3.6	nothing	1	2,500	3.2
240021	DL-19-A1.6	19	5	6.6	1.6	3.5	φ 4 × 100°	1	2,000	10.4
240040	DL-22-A1.6	22	5	6.6	1.6 ^{±0.5}	3.5	φ 4 × 100°	1	1,000	6.5
240080	DL-26-A1.6	26	5	6.6	1.6	3.5	φ 4 × 100°	1	1,000	7.5
240120	DL-19-B1.6	19	—	6.6	1.6	8 ^{±0.5}	—	2	1,500	9.0
240140	DL-22-B1.6	22	—	6.6	1.6	8 ^{±0.5}	—	2	1,000	7.4
240159	DL-22-B2.6-7170	22	—	6.7 ^{±0.2}	2.6	8 ^{±0.5}	—	2	1,000	8.3
240145	DL-22-B5	22	—	6.7 ^{±0.2}	5	8 ^{±0.5}	—	2	1,000	9.9
240152	DL-22-B8.7	22 ^{±0.2}	—	7 ^{±0.2}	8.7	11 ^{±0.5}	—	2	1,000	11.7
240180	DL-26-B1.6	26	—	6.6	1.6	8 ^{±0.5}	—	2	1,000	9.0

***1 Reference Dimension**

Size limits can be modified for practical applications. Please contact our sales/engineering departments for further information and assistance.

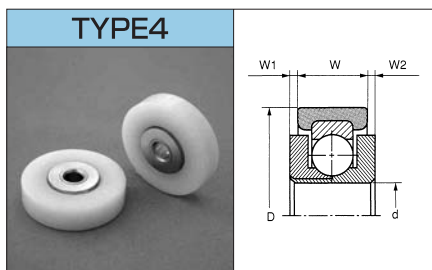
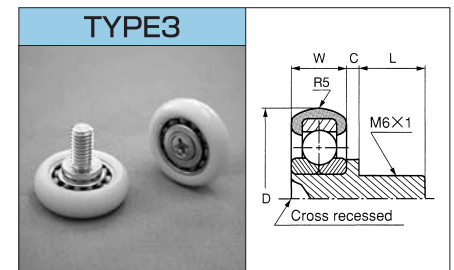
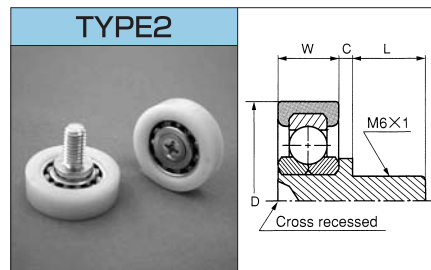
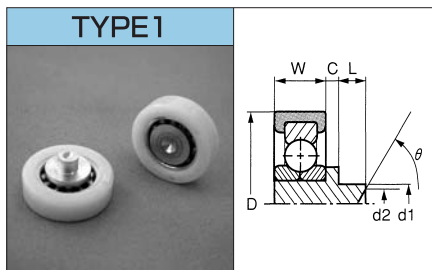

Code	Part No.	D ^{±0.1} [mm]	d ^{+0.1} [mm]	d1 _{-0.1} [mm]	W ^{±0.2} [mm]	C ^{±0.4} [mm]	L ^{±0.2} [mm]	^{*1} (d2 × θ)	W1 ^{*1} [mm]	W2 ^{*1} [mm]	Load ^{*2} [N] (kgf)	Type	Q'ty [pcs/box]	Gross Weight [kg/box]
221400	IDS-22-A1	22	—	5	7	1	3.5	φ2.5×90°	—	—	392 (40)	1	1,000	12.4
221401	IDS-22-A2.5	22	—	5	7	2.5	3.5	nothing	—	—	392 (40)	1	1,000	14.0
221403	IDS-22-A3.4-4.5	22	—	5.1	7	3.4	4.5	φ2.5×90°	—	—	392 (40)	1	1,000	13.4
221405	IDS-22-A9-5	22	—	4.2	7	9	5	nothing	—	—	392 (40)	1	1,000	15.2
221450	IDS-26-A1.5	26	—	6	8	1.5	3.5	φ5.5×90°	—	—	588 (60)	1	800	15.5
221504	IDS-22-B1.5-8	22	—	—	7	1.5	8 ^{±0.5}	—	—	—	392 (40)	2	1,000	13.2
221501	IDS-22-B1.5-11	22	—	—	7	1.5	11 ^{±0.5}	—	—	—	392 (40)	2	1,000	15.3
221505	IDS-22-B4-7	22	—	—	7	4	7 ^{±0.5}	—	—	—	392 (40)	2	1,000	14.5
221518	IDS-22-B11	22	—	—	7	11	8 ^{±0.5}	—	—	—	392 (40)	2	1,000	18.6
221600	IDS-26-B2-11	26	—	—	8	2	11 ^{±0.5}	—	—	—	588 (60)	2	500	10.2
221603	IDS-26-B5-9	26	—	—	8	5 ^{±0.5}	9 ^{±0.5}	—	—	—	588 (60)	2	500	11.1
221650	IDS-30-B2-11	30	—	—	9	2	11 ^{±0.5}	—	—	—	588 (60)	2	500	12.1
221700	IDS-26-B2-11	26 _{-0.2}	—	—	8	2	11 ^{±0.5}	—	—	—	588 (60)	3	500	10.2
221901	IDS-26-H6.35W0.8	26	6.35	—	8	—	—	—	0.8	0.8	294 (30)	4	800	16.3
221954	IDS-35-H6.35W0.26	35 _{-0.1}	6.35	—	9	—	—	—	0.26	0.26	294 (30)	4	500	13.3

***1 Reference Dimension**

***2 Allowable Load at 300min -1 (300r.p.m.)**

Size limits can be modified for practical applications. Please contact our sales/engineering departments for further information and assistance.

IN

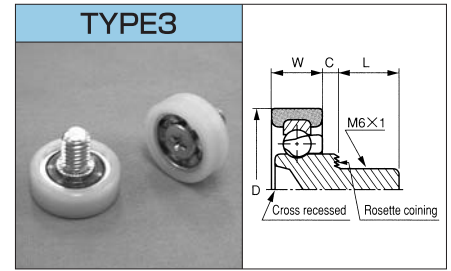
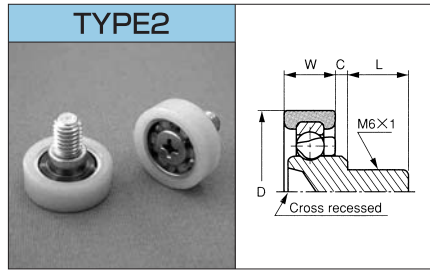
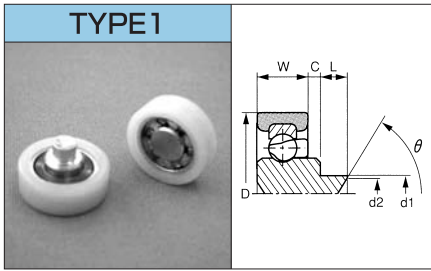

Code	Part No.	D _{-0.3} ⁰ [mm]	d1 _{-0.1} ⁰ [mm]	W ^{±0.2} [mm]	C ^{±0.4} [mm]	L ^{±0.2} [mm]	(d2×θ) ^{*1}	Load ^{*2} [N] (kgf)	Type	Q'ty [pcs/box]	Gross Weight [kg/box]
220000	IN-19-A1.5	19	5	7	1.5	3.5	φ4.4×120°	49 (5)	1	1,500	7.4
220011	IN-19-B1	19	—	7	1	8 ^{±0.5}	—	196 (20)	2	1,500	12.2
220013	IN-19-B2.7	19	—	7	2.7	8 ^{±0.5}	—	196 (20)	2	1,500	13.4
220014	IN-19-B3	19	—	7	3	8 ^{±0.5}	—	196 (20)	2	1,500	13.5
220010	IN-19-B0.5	19	—	7	0.5	8 ^{±0.5}	—	196 (20)	3	1,500	11.9
220012	IN-19-B1.5	19	—	7	1.5	8 ^{±0.5}	—	196 (20)	3	1,500	12.5

***1 Reference Dimension**

***2 Allowable Load at 300min -1 (300r.p.m.)**

Size limits can be modified for practical applications. Please contact our sales/engineering departments for further information and assistance.

ID

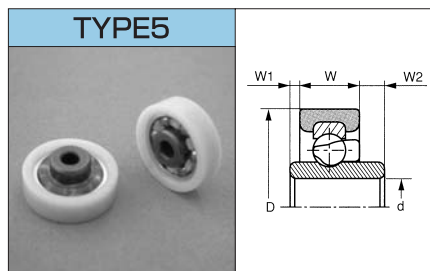
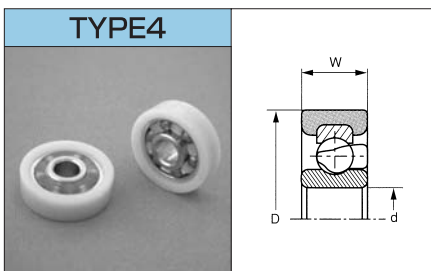
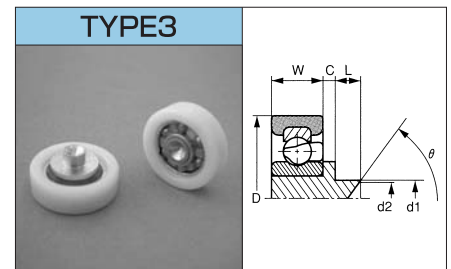
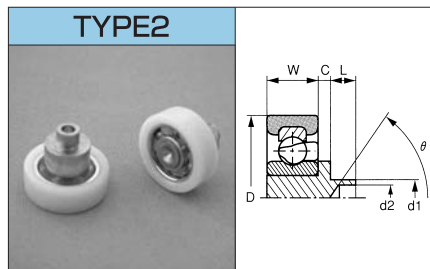
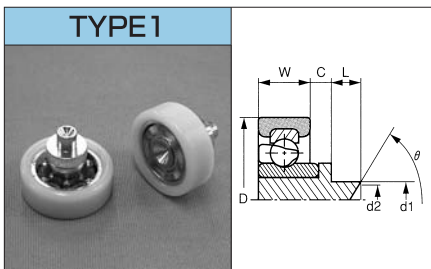

Code	Part No.	D _{-0.1} ⁰ [mm]	d ^{+0.1} [mm]	d1 _{-0.1} ⁰ [mm]	W ^{±0.2} [mm]	C ^{±0.4} [mm]	L ^{±0.2} [mm]	(d2×θ) ^{*1}	W1 ^{*1} [mm]	W2 ^{*1} [mm]	Load ^{*2} [N] (kgf)	Type	Q'ty [pcs/box]	Gross Weight [kg/box]
221101	ID-18.8-AH5	18.8	—	4	7	5	3.5	φ3 × 90°	—	—	333 (35)	1	1,500	13.0
221100	ID-18.8-AH5-5	18.8	—	4	7	5	5	φ3 × 90°	—	—	333 (35)	1	1,500	13.4
221102	ID-19-AH2.5	19 _{-0.3} ⁰	—	5	7	2.5	3.5	φ3 × 120°	—	—	333 (35)	2	1,500	12.9
221103	ID-19-AH5.5	19 _{-0.3} ⁰	—	5	7	5.5	3.5	φ3 × 120°	—	—	333 (35)	2	1,500	15.9
221110	ID-24-AH1-3.6	24 ^{±0.2}	—	6	8	1	3.6	φ5.5 × 90°	—	—	333 (35)	3	1,000	12.3
221301	ID-19-H6	19 _{-0.3} ⁰	6	—	7	—	—	—	—	—	333 (35)	4	2,000	10.5
221303	ID-22-H6	22	6	—	7	—	—	—	—	—	333 (35)	4	1,500	22.5
221304	ID-22-H4W (0.5) 3	22	4	—	7	—	—	—	0.5	3	333 (35)	5	1,000	10.2

***1 Reference Dimension**

***2 Allowable Load at 300min -1 (300r.p.m.)**

Size limits can be modified for practical applications. Please contact our sales/engineering departments for further information and assistance.

MTO & Co. AG

Tel: +41 81 300 40 00 www.mtoswiss.ch

Fax: +41 81 300 40 09 info@mtoswiss.ch

A-SERIES BEARINGS

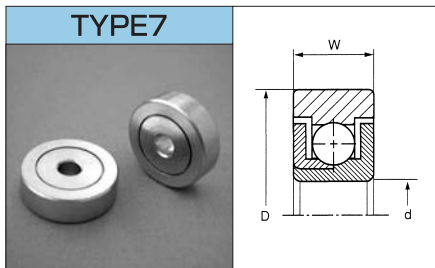
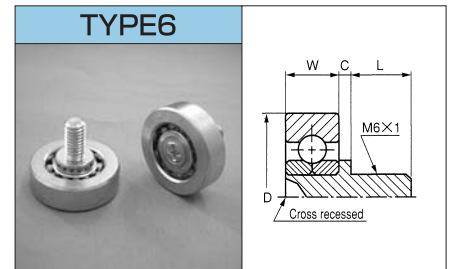
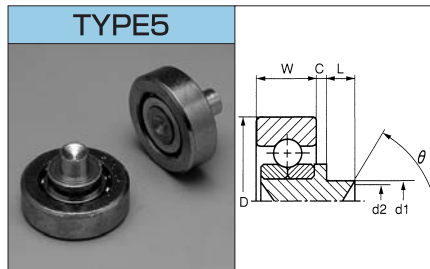
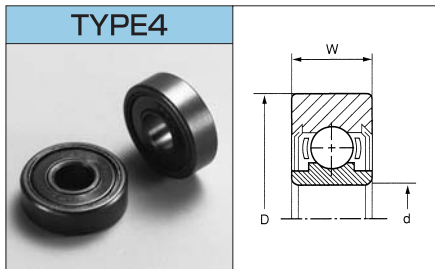
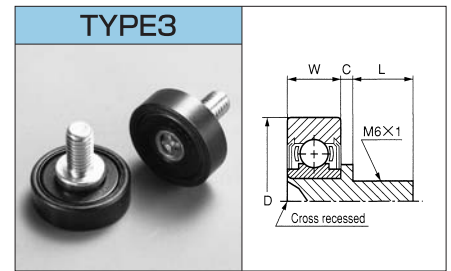
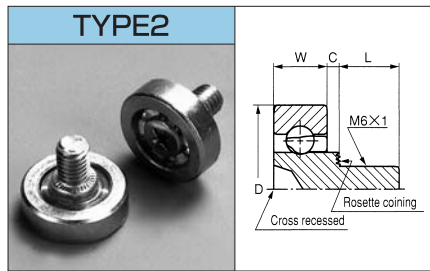
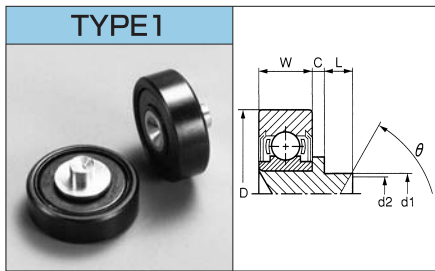

Code	Part No.	D ^{±0.1} [mm]	d ^{+0.1} [mm]	d1 ^{-0.1} [mm]	W ^{±0.2} [mm]	C ^{±0.4} [mm]	L ^{±0.2} [mm]	(d2 × θ) ^{*1}	Load ^{*2} [N] (kgf)	Type	Q'ty [pcs/box]	Gross Weight [kg/box]
230050	A-22-AH1-3.4	22	—	5	7	1	3.4	φ4.5×110°	784 (80)	1	1,000	16.2
230203	A-19-B1	19	—	—	6	1	8 ^{±0.5}	—	490 (50)	2	1,000	12.1
230204	A-19-B2	19	—	—	6	2	8 ^{±0.5}	—	490 (50)	2	1,000	12.7
230207	A-19-B2.7	19	—	—	6	2.7	8 ^{±0.5}	—	490 (50)	2	1,000	12.8
230251	A-22-BH2.8-11	22	—	—	7	2.8	11 ^{±0.5}	—	784 (80)	3	1,000	18.0
800000	A-608ZZ-5	22	8	—	7	—	—	—	784 (80)	4	1,000	10.8
231010	AS-19-A0.5-5	19 ^{±0.05}	—	5	6 ^{±0.1}	0.5 ^{±0.3}	5	φ4.5×100~130°	490 (50)	5	1,000	19.0
231050	AS-22-A1.5	22	—	6	8	1.5	3.5	φ5.5 × 90°	686 (70)	5	1,000	18.0
231052	AS-22-A1.5-5.5	22	—	6	8	1.5	5.5	φ5 × 110°	686 (70)	5	1,000	20.1
231150	AS-26-A1.5	26	—	6	8	1.5	3.5	φ5.5 × 90°	686 (70)	5	800	23.2
231203	AS-22-B0.5-9.5	22	—	—	8	0.5	9.5 ^{±0.5}	—	686 (70)	6	1,000	19.9
231204	AS-22-B2-11	22	—	—	8	2	11 ^{±0.5}	—	686 (70)	6	1,000	21.5
231250	AS-24-B0.5-9.5	24	—	—	8	0.5	9.5 ^{±0.5}	—	686 (70)	6	500	12.3
231300	AS-26-B2-11	26	—	—	8	2	11 ^{±0.5}	—	686 (70)	6	500	15.5
231402	AS-608ZZ-2	22	8	—	7	—	—	—	294 (30)	7	500	7.6
231405	AS-26-H6	26	6	—	8 ^{±0.3}	—	—	—	294 (30)	7	800	27.8

*1 Reference Dimension

*2 Allowable Load at 300min⁻¹ (300r.p.m.)

Size limits can be modified for practical applications. Please contact our sales/engineering departments for further information and assistance.

MTO & Co. AG

Tel: +41 81 300 40 00 www.mtoswiss.ch
 Fax: +41 81 300 40 09 info@mtoswiss.ch



Small Diameter Press Bearings with Flanges

Offers a compact size, reduce cost, and it's lightweight (PAT.P)

Features

1. VA model of the flange/NR type of miniature Radial bearings.
2. Compact and Light weight
3. Better corrosion resistance, stainless steel Outer races and black-oxidized steel inner Races.

Applications

1. Office Equipment:
 - Copy Machines
 - Printers
2. Vending Machines

DIMENSION

TPF-613ZZ-5

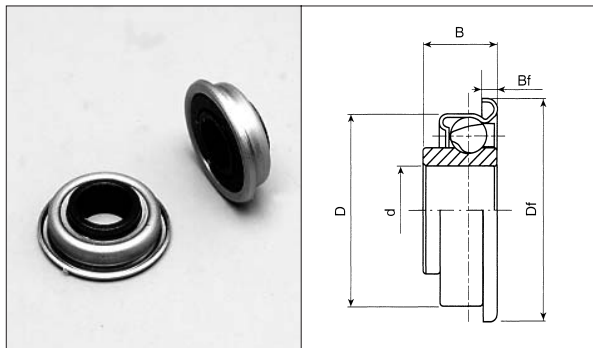

TPF-816ZZ-5

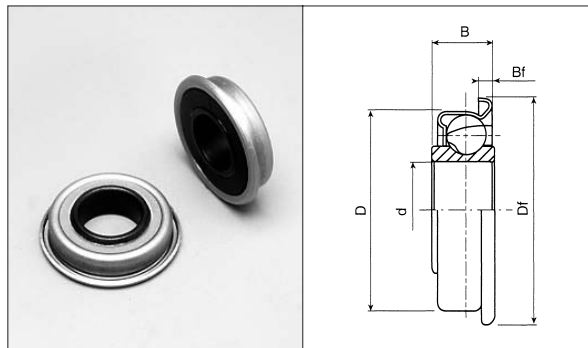

Dimension table

Code	Part No.	d ^{+0,03} [mm]	D ^{-0,05} [mm]	Df ^{±0,1} [mm]	B ^{-0,1} [mm]	Bf ^{±0,1} [mm]	Load * [N] (kgf)	Remarks
750001	TPF-613ZZ-5	6	13	15.2	5	1.1	19.6 (2)	VA model of JIS 686ZZ (Flanged and NR type)
750101	TPF-816ZZ-5	8	16	18.2	5	1.1	19.6 (2)	VA model of JIS 688ZZ (Flanged and NR type)

* Tested at an allowable load of 1500rpm-1 for 100,000,000 rotations in our companies testing facility.

DESIGN SPECIFICATIONS

1. Recommended mounting bore diameter
 TPF-613ZZ-5 : 13mm+0.05/-0 diameter
 TPF-816ZZ-5 : 16mm+0.05/-0 diameter
2. Recommended plate thickness : 1.2 ≤
3. Operational Temperature : 0 degrees C – 80 degrees C
4. Storage Temperature : – 20 degrees C – 100 degrees C

ENDURANCE DATA

TEST SAMPLE TPF-613ZZ-5
 ROTATION OF INNER RACES
 USING A 5.99 DIA SHAFT

TPF-816ZZ-5
 ROTATION OF INNER RACES
 USING A 7.99 DIA SHAFT

TEST CONDITION TOK'S TEST EQUIPMENT
 RADIAL LOAD 19.6N (2kgf)

RPM's 1500
 REVOLUTION REPEATED ROTATION
 MODE OF THE INNER RACES

TOTAL REVOLUTIONS 108,000,000 CYCLES

TEMPERATURE 23 DEGREES "C" +/-2

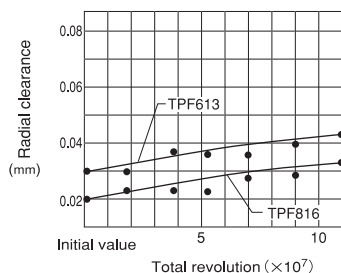

Variation of radial clearance

	TPF-613ZZ-5 Radial clearance [mm]	TPF-816ZZ-5 Radial clearance [mm]
Initial value	0.030	0.020
1.8×10 ⁷	0.030	0.025
3.6×10 ⁷	0.040	0.025
5.4×10 ⁷	0.040	0.025
7.2×10 ⁷	0.040	0.030
9.0×10 ⁷	0.045	0.030
10.8×10 ⁷	0.050	0.035
Variation value	+0.020	+0.015

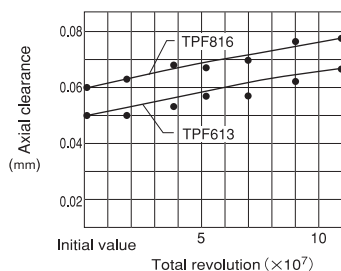

Variation of axial clearance

	TPF-613ZZ-5 Axial clearance [mm]	TPF-816ZZ-5 Axial clearance [mm]
Initial value	0.050	0.060
1.8×10 ⁷	0.050	0.065
3.6×10 ⁷	0.055	0.070
5.4×10 ⁷	0.060	0.070
7.2×10 ⁷	0.060	0.075
9.0×10 ⁷	0.065	0.080
10.8×10 ⁷	0.070	0.080
Variation value	+0.020	+0.020

DIMENSION

THF-612ZZ-4.5

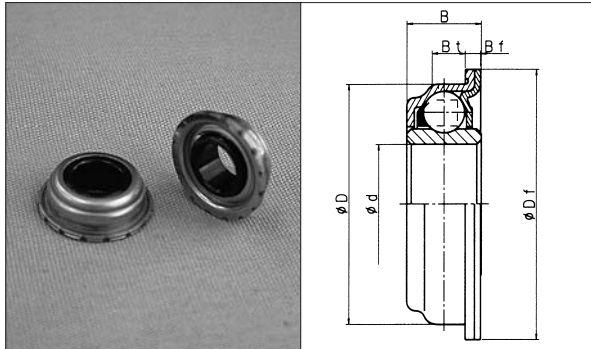

THF-816ZZ-5

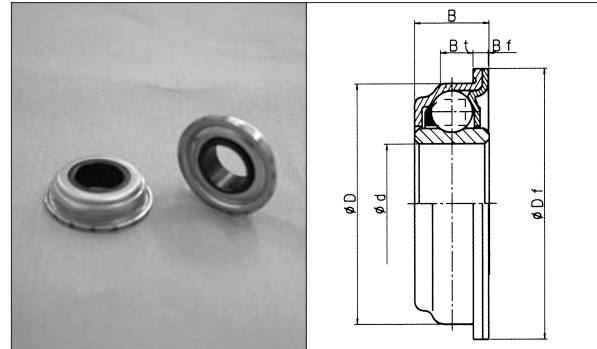

Dimension table

Code	Part No.	$d^{+0.03}$ [mm]	$D_{-0.05}$ [mm]	$Df^{\pm 0.1}$ [mm]	$B_{-0.1}$ [mm]	Bf [mm]	$Bt^{+0.2}$ [mm]	Load * [N] (kgf)	Remarks
760001	THF-612ZZ-4.5	6	12	14	4.5	$0.8^{\pm 0.1}$	1.8	49 (5)	
760002	THF-816ZZ-5	8	16	18	5	$1.1_{-0.2}^{\pm 0.1}$	1.8	78.4 (8)	VA model of JIS 688ZZ (Flanged and NR type)

* Tested at an allowable load of 1500min-1 for 100,000,000 rotations in our companies testing facility.

DESIGN SPECIFICATIONS

1. Recommended mounting bore diameter
THF-612ZZ-4.5 : 12mm+0.05/-0 diameter
THF-816ZZ-5 : 16mm+0.05/-0 diameter
2. Recommended plate thickness : $1.2 \leq$
3. Operational Temperature : 0 degrees C ~80 degrees C
4. Storage Temperature : -20 degrees C ~100 degrees C

ENDURANCE DATA

TEST SAMPLE THF-612ZZ-4.5
ROTATION OF INNER RACES
USING A 5.99 DIA SHAFT

THF-816ZZ-5
ROTATION OF INNER RACES
USING A 7.99 DIA SHAFT

TEST CONDITION TOK'S TEST EQUIPMENT
RADIAL LOAD 49.0N(5kgf) : THF-612ZZ-4.5
78.4N(8kgf) : THF-816ZZ-5

REVOLUTION 1500 min⁻¹
MODE ROTATION OF 6 SECONDS
STOP FOR 1 SECOND

TOTAL 100,000,000 CYCLES
REVOLUTIONS

TEMPERATURE 23 DEGREES °C" +/-2

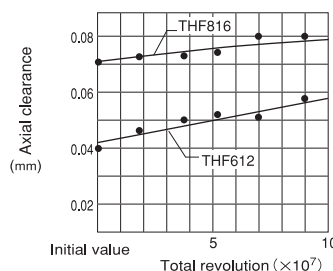
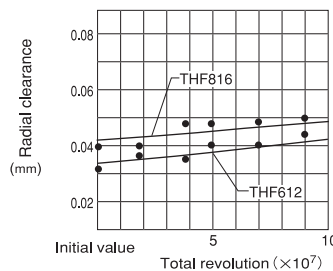

Variation of radial clearance

	THF-612ZZ-4.5 Radial clearance [mm]	THF-816ZZ-5 Radial clearance [mm]
Initial value	0.030	0.040
1.0×10^7	0.035	0.040
3.0×10^7	0.035	0.050
5.0×10^7	0.040	0.050
7.0×10^7	0.040	0.050
9.0×10^7	0.045	0.050
11.0×10^7	0.045	0.050
Variation value	+0.015	+0.010

Variation of axial clearance

	THF-612ZZ-4.5 Axial clearance [mm]	THF-816ZZ-5 Axial clearance [mm]
Initial value	0.040	0.070
1.0×10^7	0.045	0.070
3.0×10^7	0.050	0.070
5.0×10^7	0.050	0.070
7.0×10^7	0.050	0.080
9.0×10^7	0.055	0.080
11.0×10^7	0.060	0.080
Variation value	+0.020	+0.010

Produkte

Miniaturlager

Miniature Bearings Roule
Roulements miniatures

Kugel & Rollenlager

Ball and Roller Bearings
Billes et à rouleaux

Nadellager

Needle Roller Bearings
Roulements à aiguilles

Gehäuselager

Bearing Unites
Paliers

Gelenklager

Spherical Plain
Rotules

Lineartechnik

Linear Technology
Linear Technology

Gleitlager

Plain Bearings
Paliers lisses

Dichtungen

Seals
Scellés

Zubehör

Accessories

for more....



High Technology for Professionals

Tel: +41 81 300 40 00
Fax: +41 81 300 40 00

www.mtoswiss.ch
info@mtoswiss.ch