

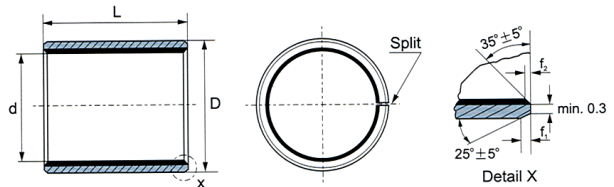

**GLEITLAGER  
PALIERS LISSES**

INHALTSVERZEICHNIS

**Gleitlagerbüchsen  
Wartungsfrei FB50**



... 7-15

**Gleitlagerflanschbüchse  
wartungsfrei FB50-F**

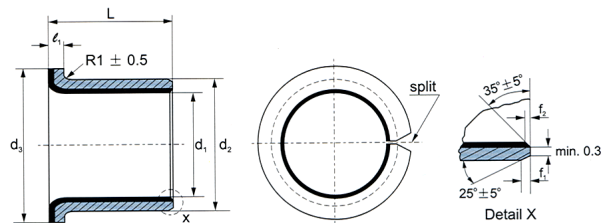

...16-17

**Anlaufscheiben**

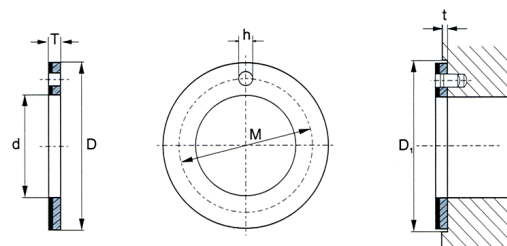

.....18

**FB2 wartungsarme Gleitlager  
mit Fettaschen zum nachschmieren**

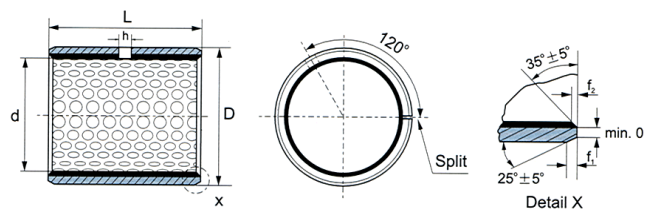

...19-26

**Weitere Typen**

.....27

**Produkte**

.....28

## FB50 PTFE beschichtete Gleitlager wartungsfrei

**Das wartungsfreie Gleitlager**

FB50 – Lager erfordern aufgrund ihres Aufbaus weder eine Initialschmierung noch Schmierintervalle. Sie sind vollkommen wartungsfrei.

**Das wartungsfreie Gleitlager**

Die Gleitschicht aus PTFE und Blei verbessert die Schmiereigenschaften und ergibt den kleinsten Reibungskoeffizient aller vergleichbaren Materialien.

**Abnützung & Reibung**

Die Gleitschicht aus PTFE mit Zusätzen verbessert die Schmiereigenschaften und ergibt den kleinsten Reibungskoeffizient aller vergleichbaren Materialien.

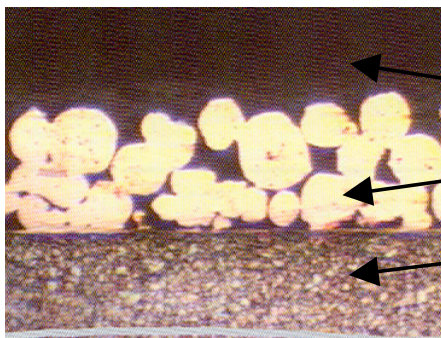
**Merkmale von FB50**

PTFE mit Zusätzen versetzt 0.01 - 0.03 mm

Gesinterte Bronzeschicht 0.20 - 0.35 mm

Stahlrücken verzinkt

Abbildung 1

- Der Stahlrücken erhöht die mechanische Festigkeit und bewirkt eine minimale Wärmeausdehnung.
- Auf dem Stahlrücken aufgesinterte poröse Schicht aus Bronze.
- Die Poren dieser Schicht werden mit PTFE, welches mit Zusätzen versetzt ist, aufgefüllt. PTFE hat die höchste Warmfestigkeit aller Kunststoffe.
- Anwendung ohne Zusatzschmierung
- Hohe Belastbarkeit
- Gute Abriebfestigkeit ergibt eine lange Lebensdauer
- Geeignet für oszillierende und unterbrochene Bewegungen
- Kein Slip-Stick aufgrund der gewählten Materialien

**Anwendungen wenn**

- Kein Ölfilm aufgrund hoher Lasten oder unterbrochenen Bewegungen aufgebaut werden kann.
- Keine Ölschmierung eingesetzt werden kann
- Keine Schmierintervalle vorgesehen sind
- Ölimprägnierte Lager ungeeignet sind
- Kosteneinsparungen gefordert werden.

**Vorteile**

- Einfache Konstruktion und niedriger Preis
- Kompaktere Bauweise
- Grössere Wellentoleranzen
- Grössere Gehäusebohrungstoleranzen
- Ausgezeichnete Gleiteigenschaften in axialer Richtung

## FB50 PTFE beschichtete Gleitlager wartungsfrei

## Merkmale von FB50

**Auslegung:**

**Folgende Punkte sind zur Auslegung eines Lagers zu beachten!**

- PV-Wert  $N/mm^2 \cdot m/s$
- Spezifische Belastung  $N/mm^2 \cdot m/s$
- Gleitgeschwindigkeit  $m/s$
- Lagerart z.B, Buchse, Anlaufscheibe
- Verschleiss steigt mit der Temperatur
- Oberflächengüte vorzugsweise geschliffen
- Gegenlaufmaterial vorzugsweise Stahl

**Mechanische Eigenschaften**

- Einsetzbarer Temperaturbereich  $0^\circ C + 280^\circ C$
- Zulässige statische Flächenpressung  $250 N/mm^2$
- Max. Gleitgeschwindigkeit  $2m/Sek.$
- Wärmeausdehnungskoeffizient:
  - Parallel zur Lageroberfläche  $11 \cdot 10^{-6}/K$
  - Rechtwinkling  $30 \cdot 10^{-6}/K$
- Wärmeleitfähigkeit  $40 W/K.M$
- Reibungskoeffizient  $0,03-0,20$

## Grafische Darstellung der Belastung

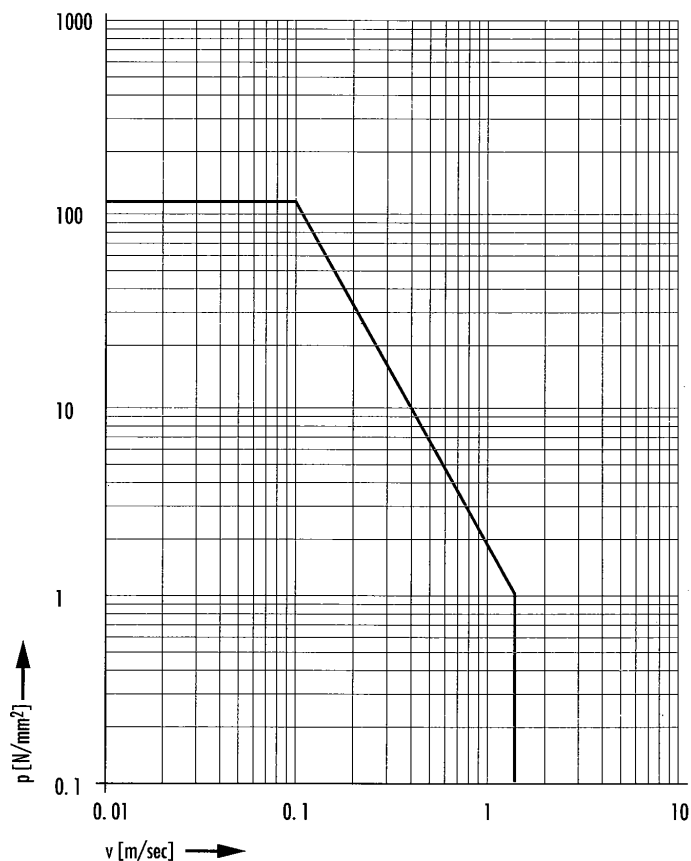

Zulässige Belastung in Abhängigkeit der Gleitgeschwindigkeit.

Abbildung 2

FB50 PTFE beschichtete Gleitlager wartungsfrei

Grafische Darstellung der Reibung

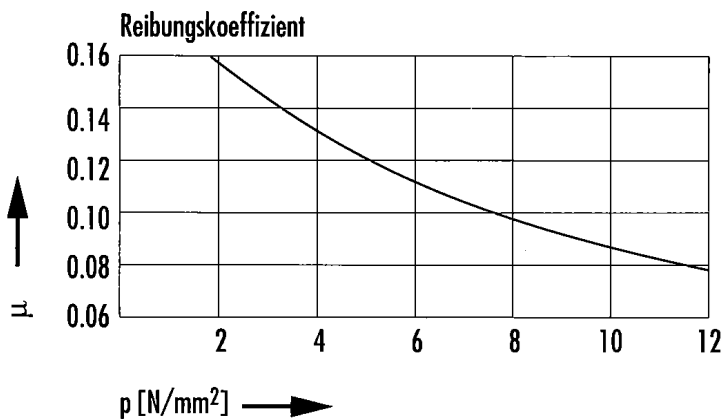

Die Reibung in FB50-Lagern hängt in erster Linie von der Lagerbelastung ab. Die Reibzahl liegt je nach Betriebsverhältnissen zwischen 0,03 und 0,20.

Abbildung 3

Grafische Darstellung der Abnutzung

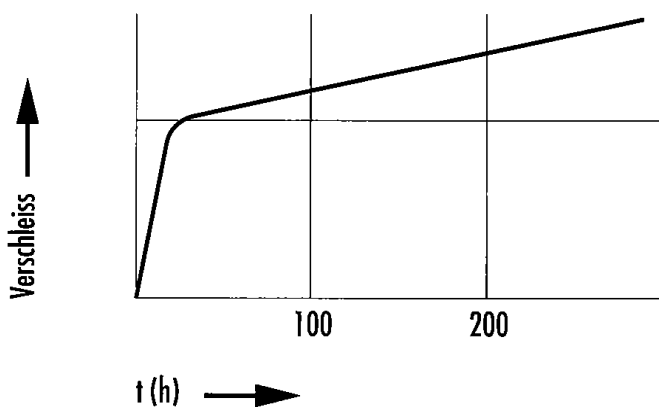

Auch die Abnutzung kann in Funktion der Flächenbelastung angesehen werden, wobei die grösste Abnutzung während der Einlaufphase stattfindet, wie die Abbildung 4 zeigt.

Abbildung 4

Grafische Darstellung der Abnutzung in Abhängigkeit der Zeit

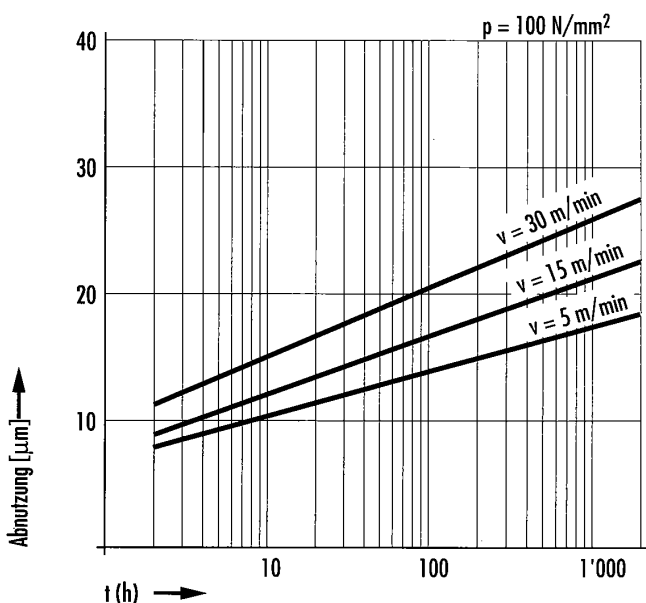

Die Abbildung 5 zeigt die Abnutzung in Abhängigkeit der Zeit bei einer spezifischen Flächenbelastung von 100 N/mm<sup>2</sup>. Diese Resultate sind Näherungswerte, welche von den Betriebsverhältnissen massgeblich beeinflusst werden.

Abbildung 5

FB50 PTFE beschichtete Gleitlager wartungsfrei

Lagertemperatur in °C

Grafische Darstellung des Koeffizientes

	25	50	100	150	200	280
1		0.9	0.6	0.4	0.2	0.1
2		1.5	1	0.6	--	--

Welle  
Stahl geschmiert  
Stahl nicht geschmiert

Abbildung 6

Lebensdauer

- FB50 Gleitlager sind einbaufertig.
- Sie dürfen nicht spanabhebend bearbeitet werden
- Die verwendeten Wellen sollten bis zu einem Durchmesser von 55 mm eine Toleranz von f7 haben und ab 55 mm eine Toleranz von h8 haben
- Die empfohlene Oberflächengüte liegt bei Ra 0.8
- Die Gehäusebohrung sollte in einer Toleranz von H7 gefertigt werden.
- Der Einbau von FB50-Lagern muss mit Sorgfalt erfolgen. Zweckmässigerweise verwendet man dazu einen Einpressdorn. Vermeiden Sie es, die Oberfläche zu beschädigen.
- Durch eine Einlaufphase bei gemässiger Geschwindigkeit und Last können Sie die Lebensdauer erhöhen.

Formel um die Näherungswerte zu berechnen

$$H = \frac{2 \cdot 10^3 \cdot f}{p \cdot v}$$

Für kontinuierlichen Lauf

H = Lebensdauer in Stunden

$$H = \frac{10^3 \cdot f}{p \cdot v}$$

Für oszillierende Bewegungen

f = Temperaturkoeffizient

$$H = \frac{0.75 \cdot 10^3 \cdot f}{p \cdot v}$$

Für Axiallager

P = Spez. Flächenbelastung in N/mm<sup>2</sup>

v = Gleitgeschwindigkeit in m/ Sek.

Grafische Darstellung der Belastung

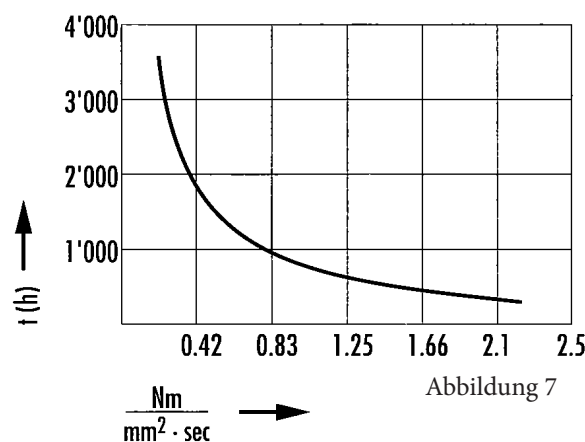

P = Spez. Flächenbelastung ( N/mm<sup>2</sup>)

V = Gleitgeschwindigkeit

Abbildung 7

Gleitlagerbüchsen wartungsfrei FB50

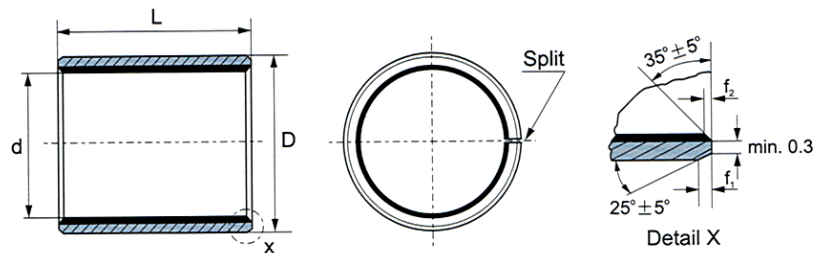

Bezeichnung	d	D	L	Wellendurchmesser		Gehäusebohrung		f1	f2
					Toleranz h8		Toleranz H7		
0303 FB50	3	4.5	3	3	-0.010 / -0.025	4.5	+0.012	0.5	0.3
0304 FB50	3	4.5	4	3	-0.010 / -0.025	4.5	+0.012	0.5	0.3
0305 FB50	3	4.5	5	3	-0.010 / -0.025	4.5	+0.012	0.5	0.3
0306 FB50	3	4.5	6	3	-0.010 / -0.025	4.5	+0.012	0.5	0.3
0403 FB50	4	5.5	3	4	-0.010 / -0.025	5.5	+0.012	0.5	0.3
0404 FB50	4	5.5	4	4	-0.010 / -0.025	5.5	+0.012	0.5	0.3
0405 FB50	4	5.5	5	4	-0.010 / -0.025	5.5	+0.012	0.5	0.3
0406 FB50	4	5.5	6	4	-0.010 / -0.025	5.5	+0.012	0.5	0.3
0408 FB50	4	5.5	8	4	-0.010 / -0.025	5.5	+0.012	0.5	0.3
0410 FB50	4	5.5	10	4	-0.010 / -0.025	5.5	+0.012	0.5	0.3
0504 FB50	5	7	4	5	-0.013 / -0.028	7	+0.015	0.5	0.3
0505 FB50	5	7	5	5	-0.013 / -0.028	7	+0.015	0.5	0.3
0508 FB50	5	7	8	5	-0.013 / -0.028	7	+0.015	0.5	0.3
0510 FB50	5	7	10	5	-0.013 / -0.028	7	+0.015	0.5	0.3
0604 FB50	6	8	4	6	-0.013 / -0.028	8	+0.015	0.5	0.3
0605 FB50	6	8	5	6	-0.013 / -0.028	8	+0.015	0.5	0.3
0606 FB50	6	8	6	6	-0.013 / -0.028	8	+0.015	0.5	0.3
0608 FB50	6	8	8	6	-0.013 / -0.028	8	+0.015	0.5	0.3
0610 FB50	6	8	10	6	-0.013 / -0.028	8	+0.015	0.5	0.3
0805 FB50	8	10	5	8	-0.013 / -0.028	10	+0.015	0.5	0.3
0806 FB50	8	10	6	8	-0.013 / -0.028	10	+0.015	0.5	0.3
0808 FB50	8	10	8	8	-0.013 / -0.028	10	+0.015	0.5	0.3
0810 FB50	8	10	10	8	-0.013 / -0.028	10	+0.015	0.5	0.3
0812 FB50	8	10	12	8	-0.013 / -0.028	10	+0.015	0.5	0.3
1006 FB50	10	12	6	10	-0.016 / -0.034	12	+0.018	0.5	0.3
1008 FB50	10	12	8	10	-0.016 / -0.034	12	+0.018	0.5	0.3
1010 FB50	10	12	10	10	-0.016 / -0.034	12	+0.018	0.5	0.3
1012 FB50	10	12	12	10	-0.016 / -0.034	12	+0.018	0.5	0.3
1015 FB50	10	12	15	10	-0.016 / -0.034	12	+0.018	0.5	0.3
1020 FB50	10	12	20	10	-0.016 / -0.034	12	+0.018	0.5	0.3

Gleitlagerbüchsen wartungsfrei FB50

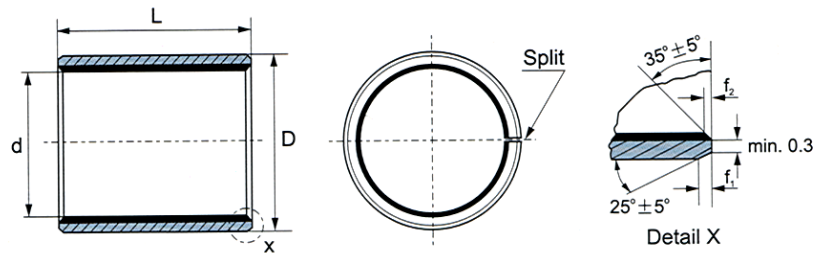

Bezeichnung	d	D	L	Wellendurchmesser		Gehäusebohrung		f1	f2
				Toleranz h8		Toleranz H7			
1206 FB50	12	14	6	12	-0.016 / -0.034	14	+0.018	0.5	0.3
1208 FB50	12	14	8	12	-0.016 / -0.034	14	+0.018	0.5	0.3
1210 FB50	12	14	10	12	-0.016 / -0.034	14	+0.018	0.5	0.3
1212 FB50	12	14	12	12	-0.016 / -0.034	14	+0.018	0.5	0.3
1215 FB50	12	14	15	12	-0.016 / -0.034	14	+0.018	0.5	0.3
1220 FB50	12	14	20	12	-0.016 / -0.034	14	+0.018	0.5	0.3
1225 FB50	12	14	25	12	-0.016 / -0.034	14	+0.018	0.5	0.3
1308 FB50	13	15	8	13	-0.016 / -0.034	15	+0.018	0.5	0.3
1310 FB50	13	15	10	13	-0.016 / -0.034	15	+0.018	0.5	0.3
1315 FB50	13	15	15	13	-0.016 / -0.034	15	+0.018	0.5	0.3
1320 FB50	13	15	20	13	-0.016 / -0.034	15	+0.018	0.5	0.3
1405 FB50	14	16	5	14	-0.016 / -0.034	16	+0.018	0.5	0.3
1410 FB50	14	16	10	14	-0.016 / -0.034	16	+0.018	0.5	0.3
1412 FB50	14	16	12	14	-0.016 / -0.034	16	+0.018	0.5	0.3
1415 FB50	14	16	15	14	-0.016 / -0.034	16	+0.018	0.5	0.3
1420 FB50	14	16	20	14	-0.016 / -0.034	16	+0.018	0.5	0.3
1425 FB50	14	16	25	14	-0.016 / -0.034	16	+0.018	0.5	0.3
1508 FB50	15	17	8	15	-0.016 / -0.034	17	+0.018	0.5	0.3
1510 FB50	15	17	10	15	-0.016 / -0.034	17	+0.018	0.5	0.3
1512 FB50	15	17	12	15	-0.016 / -0.034	17	+0.018	0.5	0.3
1515 FB50	15	17	15	15	-0.016 / -0.034	17	+0.018	0.5	0.3
1520 FB50	15	17	20	15	-0.016 / -0.034	17	+0.018	0.5	0.3
1525 FB50	15	17	25	15	-0.016 / -0.034	17	+0.018	0.5	0.3
1605 FB50	16	18	5	16	-0.016 / -0.034	18	+0.018	0.5	0.3
1610 FB50	16	18	10	16	-0.016 / -0.034	18	+0.018	0.5	0.3
1612 FB50	16	18	12	16	-0.016 / -0.034	18	+0.018	0.5	0.3
1615 FB50	16	18	15	15	-0.016 / -0.034	18	+0.018	0.5	0.3
1620 FB50	16	18	20	16	-0.016 / -0.034	18	+0.018	0.5	0.3
1625 FB50	16	18	25	16	-0.016 / -0.034	18	+0.018	0.5	0.3



Gleitlagerbüchsen wartungsfrei FB50

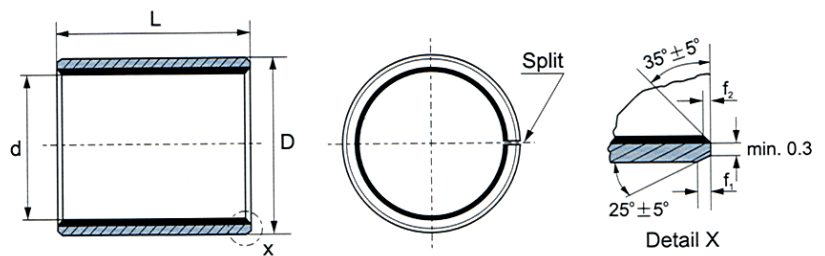

Bezeichnung	d	D	L	Wellendurchmesser		Gehäusebohrung		f1	f2
				Toleranz h8		Toleranz H7			
1710 FB50	17	19	10	17	-0.016 / -0.034	19	+0.018	0.5	0.3
1712 FB50	17	19	12	17	-0.016 / -0.034	19	+0.018	0.5	0.3
1715 FB50	17	19	15	17	-0.016 / -0.034	19	+0.018	0.5	0.3
1720 FB50	17	19	20	17	-0.016 / -0.034	19	+0.018	0.5	0.3
1808 FB50	18	20	8	18	-0.020 / -0.041	20	+0.021	0.5	0.3
1810 FB50	18	20	10	18	-0.020 / -0.041	20	+0.021	0.5	0.3
1812 FB50	18	20	12	18	-0.020 / -0.041	20	+0.021	0.5	0.3
1815 FB50	18	20	15	18	-0.020 / -0.041	20	+0.021	0.5	0.3
1820 FB50	18	20	20	18	-0.020 / -0.041	20	+0.021	0.5	0.3
1825 FB50	18	20	25	18	-0.020 / -0.041	20	+0.021	0.5	0.3
2005 FB50	20	23	5	20	-0.020 / -0.041	23	+0.021	0.8	0.4
2010 FB50	20	23	10	20	-0.020 / -0.041	23	+0.021	0.8	0.4
2012 FB50	20	23	12	20	-0.020 / -0.041	23	+0.021	0.8	0.4
2015 FB50	20	23	15	20	-0.020 / -0.041	23	+0.021	0.8	0.4
2020 FB50	20	23	20	20	-0.020 / -0.041	23	+0.021	0.8	0.4
2025 FB50	20	23	25	20	-0.020 / -0.041	23	+0.021	0.8	0.4
2030 FB50	20	23	30	20	-0.020 / -0.041	23	+0.021	0.8	0.4
2210 FB50	22	25	10	22	-0.020 / -0.041	25	+0.021	0.8	0.4
2212 FB50	22	25	12	22	-0.020 / -0.041	25	+0.021	0.8	0.4
2215 FB50	22	25	15	22	-0.020 / -0.041	25	+0.021	0.8	0.4
2220 FB50	22	25	20	22	-0.020 / -0.041	25	+0.021	0.8	0.4
2225 FB50	22	25	25	22	-0.020 / -0.041	25	+0.021	0.8	0.4
2230 FB50	22	25	30	22	-0.020 / -0.041	25	+0.021	0.8	0.4
2415 FB50	24	27	15	24	-0.020 / -0.041	27	+0.021	0.8	0.4
2420 FB50	24	27	20	24	-0.020 / -0.041	27	+0.021	0.8	0.4
2425 FB50	24	27	25	24	-0.020 / -0.041	27	+0.021	0.8	0.4
2430 FB50	24	27	30	24	-0.020 / -0.041	27	+0.021	0.8	0.4

Gleitlagerbüchsen wartungsfrei FB50

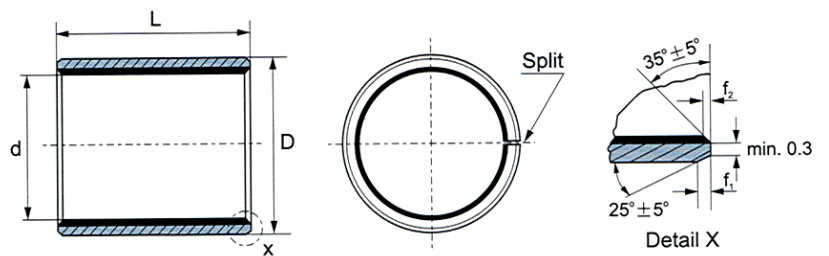

Bezeichnung	d	D	L	Wellendurchmesser		Gehäusebohrung		f1	f2
				Toleranz h8		Toleranz H7			
2505 FB50	25	28	5	25	-0.020 / -0.041	28	+0.021	0.8	0.4
2510 FB50	25	28	10	25	-0.020 / -0.041	28	+0.021	0.8	0.4
2512 FB50	25	28	12	25	-0.020 / -0.041	28	+0.021	0.8	0.4
2515 FB50	25	28	15	25	-0.020 / -0.041	28	+0.021	0.8	0.4
2520 FB50	25	28	20	25	-0.020 / -0.041	28	+0.021	0.8	0.4
2525 FB50	25	28	25	25	-0.020 / -0.041	28	+0.021	0.8	0.4
2530 FB50	25	28	30	25	-0.020 / -0.041	28	+0.021	0.8	0.4
2540 FB50	25	28	40	25	-0.020 / -0.041	28	+0.021	0.8	0.4
2550 FB50	25	28	50	25	-0.020 / -0.041	28	+0.021	0.8	0.4
2812 FB50	28	32	12	28	-0.020 / -0.041	32	+0.025	1.0	0.5
2815 FB50	28	32	15	28	-0.020 / -0.041	32	+0.025	1.0	0.5
2820 FB50	28	32	20	28	-0.020 / -0.041	32	+0.025	1.0	0.5
2825 FB50	28	32	25	28	-0.020 / -0.041	32	+0.025	1.0	0.5
2830 FB50	28	32	30	28	-0.020 / -0.041	32	+0.025	1.0	0.5
2840 FB50	28	32	40	28	-0.020 / -0.041	32	+0.025	1.0	0.5
3010 FB50	30	34	10	30	-0.025 / -0.050	34	+0.025	1.0	0.5
3012 FB50	30	34	12	30	-0.025 / -0.050	34	+0.025	1.0	0.5
3015 FB50	30	34	15	30	-0.025 / -0.050	34	+0.025	1.0	0.5
3020 FB50	30	34	20	30	-0.025 / -0.050	34	+0.025	1.0	0.5
3025 FB50	30	34	25	30	-0.025 / -0.050	34	+0.025	1.0	0.5
3030 FB50	30	34	30	30	-0.025 / -0.050	34	+0.025	1.0	0.5
3040 FB50	30	34	40	30	-0.025 / -0.050	34	+0.025	1.0	0.5
3208 FB50	32	36	8	32	-0.025 / -0.050	36	+0.025	1.0	0.5
3212 FB50	32	36	12	32	-0.025 / -0.050	36	+0.025	1.0	0.5
3220 FB50	32	36	20	32	-0.025 / -0.050	36	+0.025	1.0	0.5
3225 FB50	32	36	25	32	-0.025 / -0.050	36	+0.025	1.0	0.5
3230 FB50	32	36	30	32	-0.025 / -0.050	36	+0.025	1.0	0.5
3240 FB50	32	36	40	32	-0.025 / -0.050	36	+0.025	1.0	0.5

Gleitlagerbüchsen wartungsfrei FB50

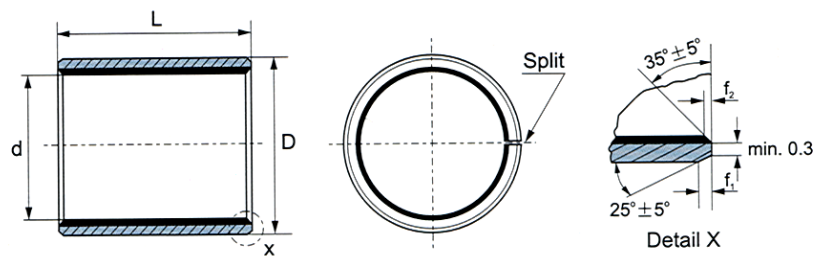

Bezeichnung	d	D	L	Wellendurchmesser		Gehäusebohrung		f1	f2
				Toleranz h8		Toleranz H7			
3512 FB50	35	39	12	35	-0.025 / -0.050	39	+0.025	1.0	0.5
3515 FB50	35	39	15	35	-0.025 / -0.050	39	+0.025	1.0	0.5
3520 FB50	35	39	20	35	-0.025 / -0.050	39	+0.025	1.0	0.5
3525 FB50	35	39	25	35	-0.025 / -0.050	39	+0.025	1.0	0.5
3530 FB50	35	39	30	35	-0.025 / -0.050	39	+0.025	1.0	0.5
3540 FB50	35	39	40	35	-0.025 / -0.050	39	+0.025	1.0	0.5
3550 FB50	35	39	50	35	-0.025 / -0.050	39	+0.025	1.0	0.5
3815 FB50	38	42	15	38	-0.025 / -0.050	42	+0.025	1.0	0.5
3820 FB50	38	42	20	38	-0.025 / -0.050	42	+0.025	1.0	0.5
3825 FB50	38	42	25	38	-0.025 / -0.050	42	+0.025	1.0	0.5
3840 FB50	38	42	40	38	-0.025 / -0.050	42	+0.025	1.0	0.5
4012 FB50	40	44	12	40	-0.025 / -0.050	44	+0.025	1.0	0.5
4015 FB50	40	44	15	40	-0.025 / -0.050	44	+0.025	1.0	0.5
4020 FB50	40	44	20	40	-0.025 / -0.050	44	+0.025	1.0	0.5
4025 FB50	40	44	25	40	-0.025 / -0.050	44	+0.025	1.0	0.5
4030 FB50	40	44	30	40	-0.025 / -0.050	44	+0.025	1.0	0.5
4040 FB50	40	44	40	40	-0.025 / -0.050	44	+0.025	1.0	0.5
4050 FB50	40	44	50	40	-0.025 / -0.050	44	+0.025	1.0	0.5
4520 FB50	45	50	20	45	-0.025 / -0.050	50	+0.025	1.2	0.6
4525 FB50	45	50	25	45	-0.025 / -0.050	50	+0.025	1.2	0.6
4530 FB50	45	50	30	45	-0.025 / -0.050	50	+0.025	1.2	0.6
4540 FB50	45	50	40	45	-0.025 / -0.050	50	+0.025	1.2	0.6
4550 FB50	45	50	50	45	-0.025 / -0.050	50	+0.025	1.2	0.6
5015 FB50	50	55	15	50	-0.025 / -0.050	55	+0.030	1.2	0.6
5020 FB50	50	55	20	50	-0.025 / -0.050	55	+0.030	1.2	0.6
5030 FB50	50	55	30	50	-0.025 / -0.050	55	+0.030	1.2	0.6
5040 FB50	50	55	40	50	-0.025 / -0.050	55	+0.030	1.2	0.6
5050 FB50	50	55	50	50	-0.025 / -0.050	55	+0.030	1.2	0.6
5060 FB50	50	55	60	50	-0.025 / -0.050	55	+0.030	1.2	0.6

Gleitlagerbüchsen wartungsfrei FB50

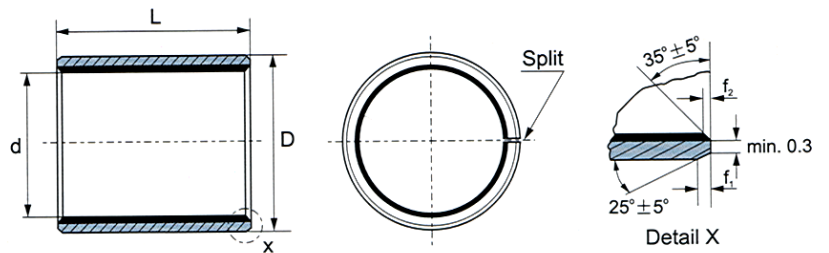

Bezeichnung	d	D	L	Wellendurchmesser		Gehäusebohrung		f1	f2
				Toleranz h8		Toleranz H7			
5520 FB50	55	60	20	55	-0.030 / -0.060	60	+0.030	1.2	0.6
5525 FB50	55	60	25	55	-0.030 / -0.060	60	+0.030	1.2	0.6
5530 FB50	55	60	30	55	-0.030 / -0.060	60	+0.030	1.2	0.6
5540 FB50	55	60	40	55	-0.030 / -0.060	60	+0.030	1.2	0.6
5550 FB50	55	60	50	55	-0.030 / -0.060	60	+0.030	1.2	0.6
5560 FB50	55	60	60	55	-0.030 / -0.060	60	+0.030	1.2	0.6
6030 FB50	60	65	30	60	-0.030 / -0.060	65	+0.030	1.2	0.6
6040 FB50	60	65	40	60	-0.030 / -0.060	65	+0.030	1.2	0.6
6050 FB50	60	65	50	60	-0.030 / -0.060	65	+0.030	1.2	0.6
6060 FB50	60	65	60	60	-0.030 / -0.060	65	+0.030	1.2	0.6
6070 FB50	60	65	70	60	-0.030 / -0.060	56	+0.030	1.2	0.6
6530 FB50	65	70	30	65	-0.030 / -0.060	70	+0.030	1.2	0.6
6540 FB50	65	70	40	65	-0.030 / -0.060	70	+0.030	1.2	0.6
6550 FB50	65	70	50	65	-0.030 / -0.060	70	+0.030	1.2	0.6
6560 FB50	65	70	60	65	-0.030 / -0.060	70	+0.030	1.2	0.6
6570 FB50	65	70	70	65	-0.030 / -0.060	70	+0.030	1.2	0.6
7030 FB50	70	75	30	70	-0.030 / -0.060	75	+0.030	1.2	0.6
7040 FB50	70	75	40	70	-0.030 / -0.060	75	+0.030	1.2	0.6
7050 FB50	70	75	50	70	-0.030 / -0.060	75	+0.030	1.2	0.6
7060 FB50	70	75	60	70	-0.030 / -0.060	75	+0.030	1.2	0.6
7070 FB50	70	75	70	70	-0.030 / -0.060	75	+0.030	1.2	0.6
7080 FB50	70	75	80	70	-0.030 / -0.060	75	+0.030	1.2	0.6
7530 FB50	75	80	30	75	-0.030 / -0.060	80	+0.030	1.2	0.6
7540 FB50	75	80	40	75	-0.030 / -0.060	80	+0.030	1.2	0.6
7550 FB50	75	80	50	75	-0.030 / -0.060	80	+0.030	1.2	0.6
7560 FB50	75	80	60	75	-0.030 / -0.060	80	+0.030	1.2	0.6
7570 FB50	75	80	70	75	-0.030 / -0.060	80	+0.030	1.2	0.6
7580 FB50	75	80	80	75	-0.030 / -0.060	80	+0.030	1.2	0.6

Gleitlagerbüchsen wartungsfrei FB50

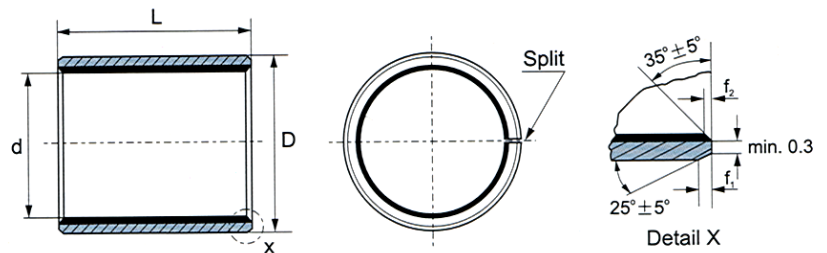

Bezeichnung	d	D	L	Wellendurchmesser		Gehäusebohrung		f1	f2
				Toleranz h8		Toleranz H7			
8040 FB50	80	85	40	80	-0.035	85	+0.035	1.4	0.7
8050 FB50	80	85	50	80	-0.035	85	+0.035	1.4	0.7
8060 FB50	80	85	60	80	-0.035	85	+0.035	1.4	0.7
8070 FB50	80	85	70	80	-0.035	85	+0.035	1.4	0.7
8080 FB50	80	85	80	80	-0.035	85	+0.035	1.4	0.7
80100 FB50	80	85	100	80	-0.035	85	+0.035	1.4	0.7
8530 FB50	85	90	30	85	-0.035	90	+0.035	1.4	0.7
8540 FB50	85	90	40	85	-0.035	90	+0.035	1.4	0.7
8550 FB50	85	90	50	85	-0.035	90	+0.035	1.4	0.7
8560 FB50	85	90	60	85	-0.035	90	+0.035	1.4	0.7
8580 FB50	85	90	80	85	-0.035	90	+0.035	1.4	0.7
85100 FB50	85	90	100	85	-0.035	90	+0.035	1.4	0.7
9040 FB50	90	95	40	90	-0.035	90	+0.035	1.4	0.7
9050 FB50	90	95	50	90	-0.035	95	+0.035	1.4	0.7
9060 FB50	90	95	60	90	-0.035	95	+0.035	1.4	0.7
9080 FB50	90	95	80	90	-0.035	95	+0.035	1.4	0.7
9090 FB50	90	95	90	90	-0.035	95	+0.035	1.4	0.7
90100 FB50	90	95	100	90	-0.035	95	+0.035	1.4	0.7
9520 FB50	95	100	20	95	-0.035	100	+0.035	1.4	0.7
9550 FB50	95	100	50	95	-0.035	100	+0.035	1.4	0.7
9560 FB50	95	100	60	95	-0.035	100	+0.035	1.4	0.7
9580 FB50	95	100	80	95	-0.035	100	+0.035	1.4	0.7
95100 FB50	95	100	100	95	-0.035	100	+0.035	1.4	0.7
10050 FB50	100	105	50	100	-0.035	105	+0.035	1.4	0.7
10060 FB50	100	105	60	100	-0.035	105	+0.035	1.4	0.7
10080 FB50	100	105	80	100	-0.035	105	+0.035	1.4	0.7
100115 FB50	100	105	115	100	-0.035	105	+0.035	1.4	0.7
10560 FB50	105	110	60	105	-0.035	110	+0.035	1.6	0.7
10580 FB50	105	110	80	105	-0.035	110	+0.035	1.6	0.7

Gleitlagerbüchsen wartungsfrei FB50

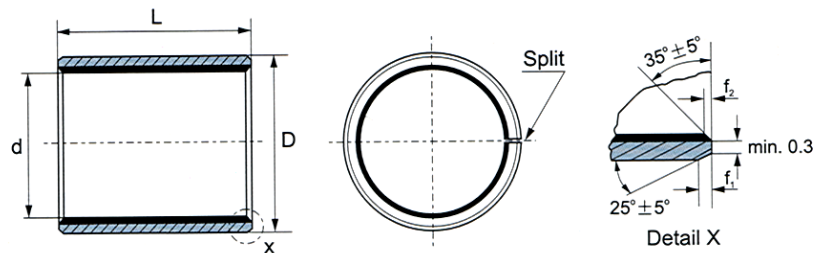

Bezeichnung	d	D	L	Wellendurchmesser		Gehäusebohrung		f1	f2
				Toleranz h8		Toleranz H7			
105115 FB50	105	110	115	105	-0.035	110	+0.035	1.6	0.7
11060 FB50	110	115	60	110	-0.035	115	+0.035	1.6	0.7
11080 FB50	110	115	80	110	-0.035	115	+0.035	1.6	0.7
110115 FB50	110	115	115	110	-0.035	115	+0.035	1.6	0.7
12060 FB50	120	125	60	120	-0.040	125	+0.035	1.6	0.8
12080 FB50	120	125	80	120	-0.040	125	+0.035	1.6	0.8
120100 FB50	120	125	100	120	-0.040	125	+0.035	1.6	0.8
12560 FB50	125	130	60	125	-0.040	130	+0.040	1.6	0.8
125100 FB50	125	130	100	125	-0.040	130	+0.040	1.6	0.8
125115 FB50	125	130	115	125	-0.040	130	+0.040	1.6	0.8
13050 FB50	130	135	50	130	-0.040	135	+0.040	1.6	0.8
13060 FB50	130	135	60	130	-0.040	135	+0.040	1.6	0.8
13080 FB50	130	135	80	130	-0.040	135	+0.040	1.6	0.8
130100 FB50	130	135	100	130	-0.040	135	+0.040	1.6	0.8
14060 FB50	140	145	60	140	-0.040	145	+0.040	1.6	0.8
14080 FB50	140	145	80	140	-0.040	145	+0.040	1.6	0.8
140100 FB50	140	145	100	140	-0.040	145	+0.040	1.6	0.8
15050 FB50	150	155	50	150	-0.040	155	+0.040	1.6	0.8
15060 FB50	150	155	60	150	-0.040	155	+0.040	1.6	0.8
15080 FB50	150	155	80	150	-0.040	155	+0.040	1.6	0.8
150100 FB50	150	155	100	150	-0.040	155	+0.040	1.6	0.8
16060 FB50	160	165	60	160	-0.040	165	+0.040	1.6	0.8
16080 FB50	160	165	80	160	-0.040	165	+0.040	1.6	0.8
160100 FB50	160	165	100	160	-0.040	165	+0.040	1.6	0.8
160115 FB50	160	165	115	160	-0.040	165	+0.040	1.6	0.8
18080 FB50	180	185	80	180	-0.046	185	+0.046	1.6	0.8
180100 FB50	180	185	100	180	-0.046	185	+0.046	1.6	0.8
19080 FB50	190	195	80	190	-0.046	195	+0.046	1.6	0.8
190100 FB50	190	195	100	190	-0.046	195	+0.046	1.6	0.8

Gleitlagerbüchsen wartungsfrei FB50

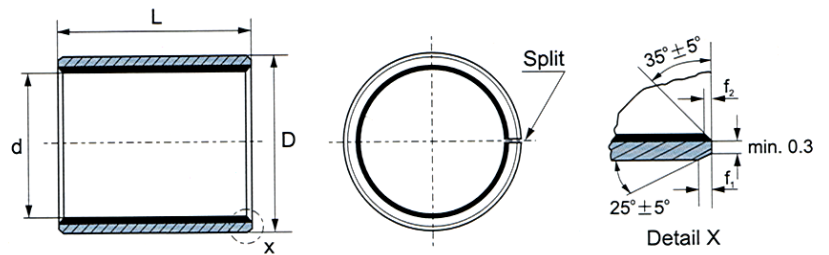

Bezeichnung	d	D	L	Wellendurchmesser		Gehäusebohrung		f1	f2
					Toleranz h8		Toleranz H7		
<b>20060 FB50</b>	200	205	60	200	-0.046	205	+0.046	1.6	0.8
<b>20080 FB50</b>	200	205	80	200	-0.046	205	+0.046	1.6	0.8
<b>200100 FB50</b>	200	205	100	200	-0.046	205	+0.046	1.6	0.8
<b>22080 FB50</b>	220	225	80	220	-0.046	225	+0.046	1.6	0.8
<b>220100 FB50</b>	220	225	100	220	-0.046	225	+0.046	1.6	0.8
<b>25080 FB50</b>	250	255	80	250	-0.052	255	+0.052	1.6	0.8
<b>250100 FB50</b>	250	255	100	250	-0.052	255	+0.052	1.6	0.8
<b>26080 FB50</b>	260	265	80	260	-0.052	265	+0.052	1.6	0.8
<b>260100 FB50</b>	260	265	100	260	-0.052	265	+0.052	1.6	0.8
<b>28080 FB50</b>	280	285	80	280	-0.052	285	+0.052	1.6	0.8
<b>280100 FB50</b>	280	285	100	280	-0.052	285	+0.052	1.6	0.8
<b>30080 FB50</b>	300	305	80	300	-0.052	305	+0.052	1.6	0.8
<b>300100 FB50</b>	300	305	100	300	-0.052	305	+0.052	1.6	0.8



Gleitlagerflanschbüchse wartungsfrei FB50-F

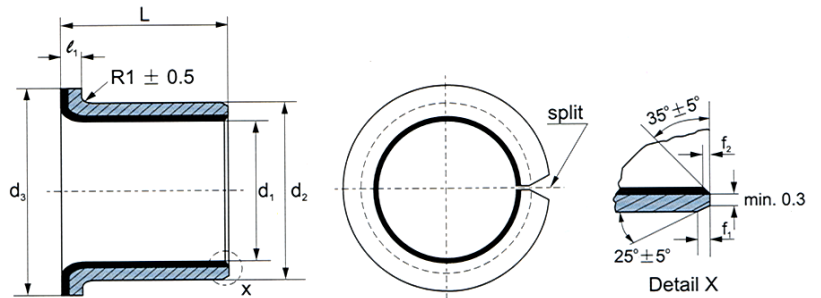

Bezeichnung	d1	d2	d3	L	L1	f1	f2
03040 FB50-F	3	4.5	7	4	0.75	0.5	0.4
04040 FB50-F	4	5.5	9	4	0.75	0.5	0.4
05050 FB50-F	5	7	10	5	1	0.5	0.4
05060 FB50-F	5	7	10	6	1	0.5	0.4
06040 FB50-F	6	8	12	4	1	0.5	0.4
06070 FB50-F	6	8	12	7	1	0.5	0.4
06090 FB50-F	6	8	12	9	1	0.5	0.4
08055 FB50-F	8	10	15	5.5	1	0.5	0.4
08075 FB50-F	8	10	15	7.5	1	0.5	0.4
08095 FB50-F	8	10	15	9.5	1	0.5	0.4
10070 FB50-F	10	12	18	7	1	0.5	0.4
10090 FB50-F	10	12	18	9	1	0.5	0.4
10120 FB50-F	10	12	18	12	1	0.5	0.4
10170 FB50-F	10	12	18	17	1	0.5	0.4
12070 FB50-F	12	14	20	7	1	0.5	0.4
12090 FB50-F	12	14	20	9	1	0.5	0.4
12120 FB50-F	12	14	20	12	1	0.5	0.4
12170 FB50-F	12	14	20	17	1	0.5	0.4
14120 FB50-F	14	16	22	12	1	0.5	0.4
14170 FB50-F	14	16	22	17	1	0.5	0.4
15080 FB50-F	15	17	23	8	1	0.5	0.4
15120 FB50-F	15	17	23	12	1	0.5	0.4
15170 FB50-F	15	17	23	17	1	0.5	0.4
16120 FB50-F	16	18	24	12	1	0.5	0.4
16170 FB50-F	16	18	24	17	1	0.5	0.4
18120 FB50-F	18	20	26	12	1	0.8	0.4
18170 FB50-F	18	20	26	17	1	0.8	0.4
20165 FB50-F	20	23	30	16.5	1.5	0.8	0.4



Gleitlagerflanschbüchse wartungsfrei FB50-F

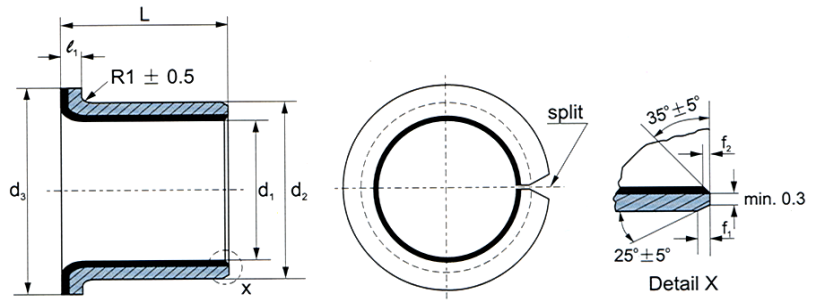

Bezeichnung	d1	d2	d3	L	L1	f1	f2
20115 FB50-F	20	23	30	11.5	1.5	0.8	0.4
20135 FB50-F	20	23	30	13.5	1.5	0.8	0.4
20165 FB50-F	20	23	30	16.5	1.5	0.8	0.4
20215 FB50-F	20	23	30	21.5	1.5	0.8	0.4
22150 FB50-F	22	25	32	15	1.5	0.8	0.4
22235 FB50-F	22	25	32	23.5	1.5	0.8	0.4
23135 FB50-F	23	26	33	13.5	1.5	0.8	0.4
25115 FB50-F	25	28	35	11.5	1.5	0.8	0.4
25165 FB50-F	25	28	35	16.5	1.5	0.8	0.4
25215 FB50-F	25	28	35	21.5	1.5	0.8	0.4
25265 FB50-F	25	28	35	26.5	1.5	0.8	0.4
30160 FB50-F	30	34	42	16	2	0.8	0.4
30260 FB50-F	30	34	42	26	2	1.0	0.5
35160 FB50-F	35	39	47	16	2	1.0	0.5
35260 FB50-F	35	39	47	26	2	1.0	0.5
40260 FB50-F	40	44	53	26	2	1.0	0.5
45320 FB50-F	45	50	54	32	2.5	1.0	0.5
50220 FB50-F	50	55	60	22	2.5	1.0	0.5
60325 FB50-F	60	65	75	32.5	2.5	1.0	0.5
60425 FB50-F	60	65	75	42.5	2.5	1.0	0.5

Anlaufscheibe

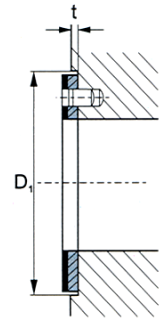
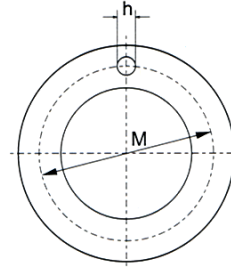
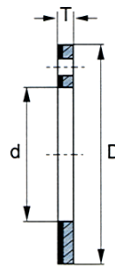

Bezeichnung	Wellendurchmesser	d +0.25	D -0.25	T -0.05	M -0.12	h	t	D1 +0.12
WC 10 FB	8	10	20	1.5	15	1.5	1	20
WC 12 FB	10	12	24	1.5	18	1.5	1	24
WC 14 FB	12	14	26	1.5	20	2	1	26
WC 16 FB	14	16	30	1.5	23	2	1	30
WC 18 FB	16	18	32	1.5	25	2	1	32
WC 20 FB	18	20	36	1.5	28	3	1	36
WC 22 FB	20	22	38	1.5	30	3	1	38
WC 24 FB	22	24	42	1.5	33	3	1	42
WC 26 FB	24	26	44	1.5	35	3	1	44
WC 28 FB	26	28	48	1.5	38	4	1	48
WC 32 FB	30	32	54	1.5	43	4	1	54
WC 38 FB	36	38	62	1.5	50	4	1	62
WC 42 FB	40	42	66	1.5	54	4	1	66
WC 48 FB	46	48	74	2	61	4	1.5	74
WC 52 FB	50	52	78	2	65	4	1.5	78
WC 62 FB	60	62	90	2	76	4	1.5	90

## Gleitlagerbüchsen mit Fetttaschen zum Nachschmieren FB2

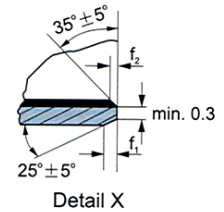
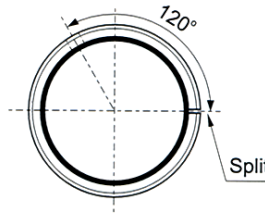
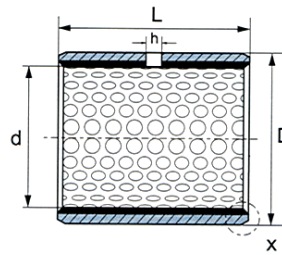
**Aufbau**

- Verkupfertes Stahlrücken mit aufgesinterter Zinnbronze
- Multiporöse Bronzeschicht
- Porenfüllung und Deckschicht (0,3-0,4mm) aus Acetalharz

**Technische Daten**

- Zulässige statische spezifische Belastung 250 N/mm<sup>2</sup>
- Zulässige dynamische spezifische Belastung 140 N/mm<sup>2</sup>
- Max. Gleitgeschwindigkeit 2,5 m/s
- Betriebstemperatur | 40° bis + 130° C
- Reibungszahl 0,01 bis 0,1
- Empfohlene Gehäusetoleranz H 7
- Empfohlene Wellentoleranz h 8
- Erforderliche Oberflächenqualität RZ < 6 RA < 0,8
- Empfohlene Wellenhärte HB 200

**Schmiermittel**

- Geeignet sind lithiumverseifte Fette ohne MoS<sub>2</sub>-Zusätze.
- Festschmierstoffe oder Fettzusätze wie Molybdänsulfid, Zinksulfid etc. sind absolut ungeeignet.
- Nachschmierung verlängert die Lebensdauer.

**Eigenschaften**

- Gut geeignet für rotierende und oszillierende Bewegungen
- Wartungsarm durch lange Nachschmierintervalle
- Geringer Verschleiss
- Kein Aufnehmen von Wasser, deshalb kein Quellen
- Gutes Dämpfungsverhalten

**Platten und Anlaufscheiben in FB2 auf Anfrage.**



Gleitlagerbüchsen mit Fetttaschen zum Nachschmieren FB2

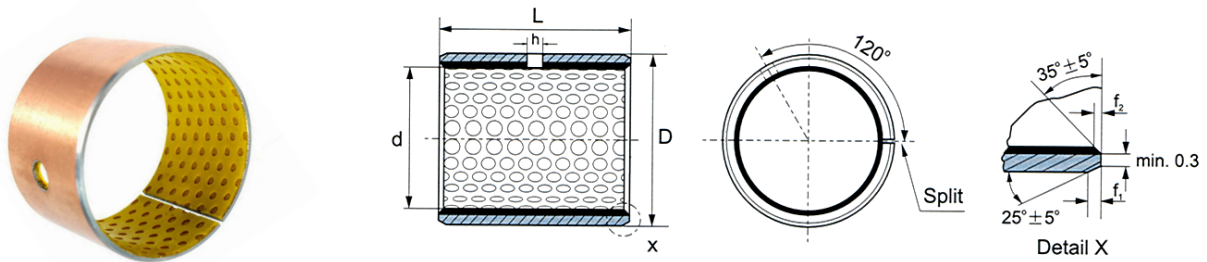

Bezeichnung	d	D	L	Wellendurchmesser		Gehäusebohrung		f1	f2
				Toleranz h8		Toleranz H7			
1010 FB2	10	12	10	10	-0.022	12	+0.018	0.5	0.3
1012 FB2	10	12	12	10	-0.027	12	+0.018	0.5	0.3
1015 FB2	10	12	15	10	-0.027	12	+0.018	0.5	0.3
1020 FB2	10	12	20	10	-0.027	12	+0.018	0.5	0.3
1210 FB2	12	14	10	12	-0.027	14	+0.018	0.5	0.3
1212 FB2	12	14	12	12	-0.027	14	+0.018	0.5	0.3
1215 FB2	12	14	15	12	-0.027	14	+0.018	0.5	0.3
1220 FB2	12	14	20	12	-0.027	14	+0.018	0.5	0.3
1225 FB2	12	14	25	12	-0.027	14	+0.018	0.5	0.3
1410 FB2	14	16	10	14	-0.027	16	+0.018	0.5	0.3
1412 FB2	14	16	12	14	-0.027	16	+0.018	0.5	0.3
1415 FB2	14	16	15	14	-0.027	16	+0.018	0.5	0.3
1420 FB2	14	16	20	14	-0.027	16	+0.018	0.5	0.3
1425 FB2	14	16	25	14	-0.027	16	+0.018	0.5	0.3
1510 FB2	15	17	10	15	-0.027	17	+0.018	0.5	0.3
1512 FB2	15	17	12	15	-0.027	17	+0.018	0.5	0.3
1515 FB2	15	17	15	15	-0.027	17	+0.018	0.5	0.3
1520 FB2	15	17	20	15	-0.027	17	+0.018	0.5	0.3
1525 FB2	15	17	25	15	-0.027	17	+0.018	0.5	0.3
1610 FB2	16	18	10	16	-0.027	18	+0.018	0.5	0.3
1612 FB2	16	18	12	16	-0.027	18	+0.018	0.5	0.3
1615 FB2	16	18	15	16	-0.027	18	+0.018	0.5	0.3
1620 FB2	16	18	20	16	-0.027	18	+0.018	0.5	0.3
1625 FB2	16	18	25	16	-0.027	18	+0.018	0.5	0.3
1810 FB2	18	20	10	18	-0.027	20	+0.021	0.5	0.3
1812 FB2	18	20	12	18	-0.027	20	+0.021	0.5	0.3
1815 FB2	18	20	15	18	-0.027	20	+0.021	0.5	0.3
1820 FB2	18	20	20	18	-0.027	20	+0.021	0.5	0.3
1825 FB2	18	20	25	18	-0.027	20	+0.021	0.5	0.3

Gleitlagerbüchsen mit Fettaschen zum Nachschmieren FB2

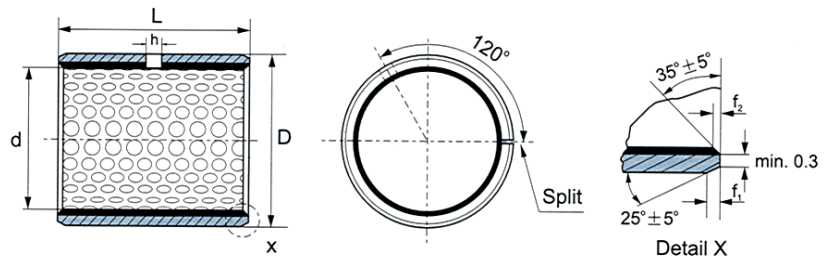
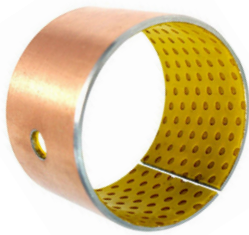

Bezeichnung	d	D	L	Wellendurchmesser		Gehäusebohrung		f1	f2
				Toleranz h8		Toleranz H7			
2010 FB2	20	23	10	20	-0.033	23	+0.021	0.8	0.4
2012 FB2	20	23	12	20	-0.033	23	+0.021	0.8	0.4
2015 FB2	20	23	15	20	-0.033	23	+0.021	0.8	0.4
2020 FB2	20	23	20	20	-0.033	23	+0.021	0.8	0.4
2025 FB2	20	23	25	20	-0.033	23	+0.021	0.8	0.4
2030 FB2	20	23	30	20	-0.033	23	+0.021	0.8	0.4
2035 FB2	20	23	35	20	-0.033	23	+0.021	0.8	0.4
2210 FB2	22	25	10	22	-0.033	25	+0.021	1.0	0.5
2212 FB2	22	25	12	22	-0.033	25	+0.021	1.0	0.3
2215 FB2	22	25	15	22	-0.033	25	+0.021	1.0	0.3
2220 FB2	22	25	20	22	-0.033	25	+0.021	1.0	0.3
2225 FB2	22	25	25	22	-0.033	25	+0.021	1.0	0.3
2230 FB2	22	25	30	22	-0.033	25	+0.021	1.0	0.3
2510 FB2	25	28	10	25	-0.033	28	+0.021	1.0	0.3
2512 FB2	25	28	12	25	-0.033	28	+0.021	1.0	0.3
2515 FB2	25	28	15	25	-0.033	28	+0.021	1.0	0.3
2520 FB2	25	28	20	25	-0.033	28	+0.021	1.0	0.3
2525 FB2	25	28	25	25	-0.033	28	+0.021	1.0	0.3
2530 FB2	25	28	30	25	-0.033	28	+0.021	1.0	0.3
2550 FB2	25	28	50	25	-0.033	28	+0.021	1.0	0.3
2815 FB2	28	32	15	28	-0.033	32	+0.021	1.0	0.3
2820 FB2	28	32	20	28	-0.033	32	+0.021	1.0	0.3
2825 FB2	28	32	25	28	-0.033	32	+0.021	1.0	0.3
2830 FB2	28	32	30	28	-0.033	32	+0.021	1.0	0.3
3012 FB2	30	34	12	30	-0.033	34	+0.025	1.0	0.3
3015 FB2	30	34	15	30	-0.033	34	+0.025	1.0	0.3
3020 FB2	30	34	20	30	-0.033	34	+0.025	1.0	0.3
3025 FB2	30	34	25	30	-0.033	34	+0.025	1.0	0.3
3030 FB2	30	34	30	30	-0.033	34	+0.025	1.0	0.3
3035 FB2	30	34	35	30	-0.033	34	+0.025	1.0	0.3
3040 FB2	30	34	40	30	-0.033	34	+0.025	1.0	0.3

Gleitlagerbüchsen mit Fetttaschen zum Nachschmieren FB2

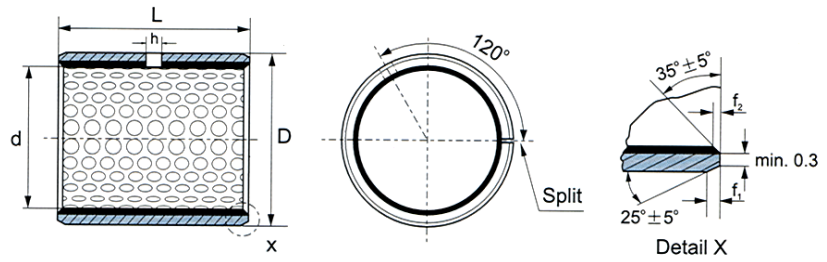
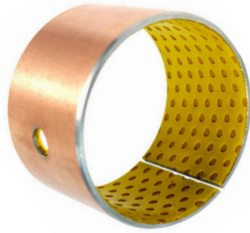

Bezeichnung	d	D	L	Wellendurchmesser		Gehäusebohrung		f1	f2
				Toleranz h8		Toleranz H7			
3512 FB2	35	39	12	35	-0.039	39	+0.025	1.0	0.3
3515 FB2	35	39	15	35	-0.039	39	+0.025	1.0	0.3
3520 FB2	35	39	20	35	-0.039	39	+0.025	1.0	0.3
3530 FB2	35	39	30	35	-0.039	39	+0.025	1.0	0.3
3535 FB2	35	39	35	35	-0.039	39	+0.025	1.0	0.3
3540 FB2	35	39	40	35	-0.039	39	+0.025	1.0	0.3
3550 FB2	35	39	50	35	-0.039	39	+0.025	1.0	0.3
4012 FB2	40	44	12	40	-0.039	44	+0.025	1.0	0.3
4020 FB2	40	44	20	40	-0.039	44	+0.025	1.0	0.4
4025 FB2	40	44	25	40	-0.039	44	+0.025	1.0	0.4
4030 FB2	40	44	30	40	-0.039	44	+0.025	1.0	0.4
4040 FB2	40	44	40	40	-0.039	44	+0.025	1.0	0.4
4050 FB2	40	44	50	40	-0.039	44	+0.025	1.0	0.4
4520 FB2	45	50	20	45	-0.039	50	+0.025	1.2	0.6
4525 FB2	45	50	25	45	-0.039	50	+0.025	1.2	0.6
4530 FB2	45	50	30	45	-0.039	50	+0.025	1.2	0.6
4540 FB2	45	50	40	45	-0.039	50	+0.025	1.2	0.6
4545 FB2	45	50	45	45	-0.039	50	+0.025	1.2	0.6
4550 FB2	45	50	50	45	-0.039	50	+0.025	1.2	0.6
5020 FB2	50	55	20	50	-0.039	55	+0.030	1.2	0.6
5030 FB2	50	55	30	50	-0.039	55	+0.030	1.2	0.6
5040 FB2	50	55	40	50	-0.039	55	+0.030	1.2	0.6
5045 FB2	50	55	45	50	-0.039	55	+0.030	1.2	0.6
5050 FB2	50	55	50	50	-0.039	55	+0.030	1.2	0.6
5055 FB2	50	55	55	50	-0.039	55	+0.030	1.2	0.6
5060 FB2	50	55	60	50	-0.039	55	+0.030	1.2	0.6

Gleitlagerbüchsen mit Fetttaschen zum Nachschmieren FB2

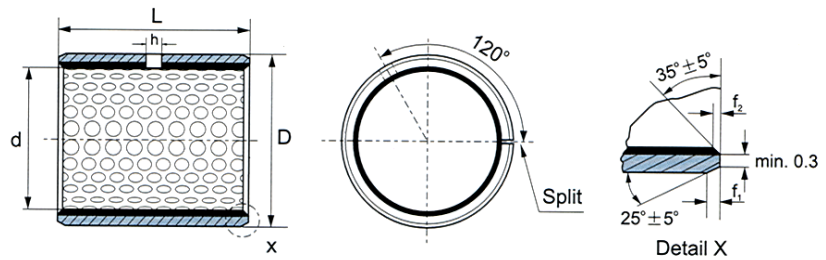
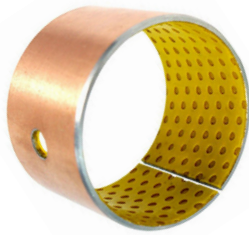

Bezeichnung	d	D	L	Wellendurchmesser		Gehäusebohrung		f1	f2
				Toleranz h8		Toleranz H7			
5520 FB2	55	60	20	55	-0.046	60	+0.030	1.2	0.6
5525 FB2	55	60	25	55	-0.046	60	+0.030	1.2	0.6
5530 FB2	55	60	30	55	-0.046	60	+0.030	1.2	0.6
5540 FB2	55	60	40	55	-0.046	60	+0.030	1.2	0.6
5550 FB2	55	60	50	55	-0.046	60	+0.030	1.2	0.6
5560 FB2	55	60	60	55	-0.046	60	+0.030	1.2	0.6
6020 FB2	60	65	20	60	-0.046	65	+0.030	1.2	0.6
6025 FB2	60	65	25	60	-0.046	65	+0.030	1.2	0.6
6030 FB2	60	65	30	60	-0.046	65	+0.030	1.2	0.6
6040 FB2	60	65	40	60	-0.046	65	+0.030	1.2	0.6
6050 FB2	60	65	50	60	-0.046	65	+0.030	1.2	0.6
6060 FB2	60	65	60	60	-0.046	65	+0.030	1.2	0.6
6540 FB2	65	70	40	65	-0.046	70	+0.030	1.2	0.8
6560 FB2	65	70	60	65	-0.046	70	+0.030	1.2	0.8
7040 FB2	70	75	40	70	-0.046	75	+0.030	1.2	0.8
7050 FB2	70	75	50	70	-0.046	75	+0.030	1.2	0.8
7080 FB2	70	75	80	70	-0.046	75	+0.030	1.2	0.8
7540 FB2	75	80	40	75	-0.046	80	+0.030	1.2	0.8
7560 FB2	75	80	60	75	-0.046	80	+0.030	1.2	0.8
7580 FB2	75	80	80	75	-0.046	80	+0.030	1.2	0.8
8040 FB2	80	85	40	80	-0.046	85	+0.035	1.4	0.8
8060 FB2	80	85	60	80	-0.046	85	+0.035	1.4	0.8
8080 FB2	80	85	80	80	-0.046	85	+0.035	1.4	0.8
8540 FB2	85	90	40	85	-0.054	90	+0.035	1.4	0.8
8560 FB2	85	90	60	85	-0.054	90	+0.035	1.4	0.8
8580 FB2	85	90	80	85	-0.054	90	+0.035	1.4	0.8
9040 FB2	90	95	40	90	-0.054	95	+0.035	1.4	0.8
9060 FB2	90	95	60	90	-0.054	95	+0.035	1.4	0.8
9080 FB2	90	95	80	90	-0.054	95	+0.035	1.4	0.8
9090 FB2	90	95	90	90	-0.054	95	+0.035	1.4	0.8
10050 FB2	100	105	50	100	-0.054	105	+0.035	1.4	0.8



Gleitlagerbüchsen mit Fetttaschen zum Nachschmieren FB2

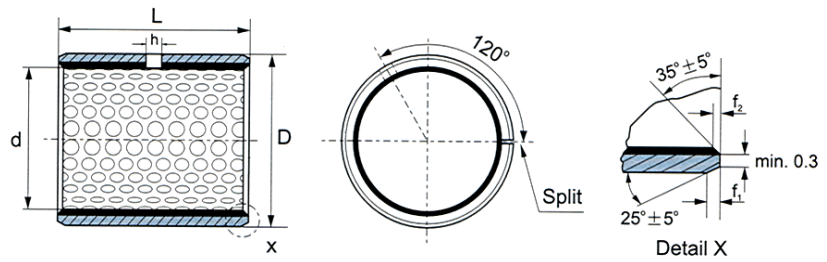
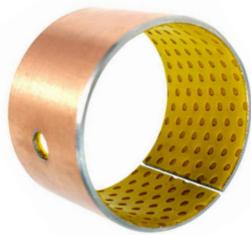

Bezeichnung	d	D	L	Wellendurchmesser		Gehäusebohrung		f1	f2
				Toleranz h8		Toleranz H7			
10080 FB2	100	105	80	100	-0.054	105	+0.035	1.4	0.8
10095 FB2	100	105	95	100	-0.054	105	+0.035	1.4	0.8
10560 FB2	105	110	60	105	-0.054	110	+0.035	1.4	0.8
10580 FB2	105	110	80	105	-0.054	110	+0.035	1.4	0.8
10595 FB2	105	110	95	105	-0.054	110	+0.035	1.4	0.8
105110 FB2	105	110	110	105	-0.054	110	+0.035	1.4	0.8
11060 FB2	110	115	60	110	-0.054	115	+0.035	1.4	0.8
11080 FB2	110	115	80	110	-0.054	115	+0.035	1.4	0.8
11095 FB2	110	115	95	110	-0.054	115	+0.035	1.4	0.8
110110 FB2	110	115	110	110	-0.054	115	+0.035	1.4	0.8
12060 FB2	120	125	60	120	-0.054	125	+0.040	1.4	0.8
12080 FB2	120	125	80	120	-0.054	125	+0.040	1.4	0.8
120110 FB2	120	125	110	120	-0.054	125	+0.040	1.4	0.8
12560 FB2	125	130	60	125	-0.063	130	+0.040	1.4	0.8
125110 FB2	125	130	110	125	-0.063	130	+0.040	1.4	0.8
13050 FB2	130	135	50	130	-0.063	135	+0.040	1.4	0.8
13060 FB2	130	135	60	130	-0.063	135	+0.040	1.4	0.8
13080 FB2	130	135	80	130	-0.063	135	+0.040	1.4	0.8
130100 FB2	130	135	100	130	-0.063	135	+0.040	1.4	0.8
14050 FB2	140	145	50	140	-0.063	145	+0.040	1.4	0.8
14060 FB2	140	145	60	140	-0.063	145	+0.040	1.4	0.8
14080 FB2	140	145	80	140	-0.063	145	+0.040	1.4	0.8
140100 FB2	140	145	100	140	-0.063	145	+0.040	1.4	0.8
15050 FB2	150	155	50	150	-0.063	155	+0.040	1.4	0.8
15060 FB2	150	155	60	150	-0.063	155	+0.040	1.4	0.8
15080 FB2	150	155	80	150	-0.063	155	+0.040	1.4	0.8
150100 FB2	150	155	100	150	-0.063	155	+0.040	1.4	0.8
16050 FB2	160	165	50	160	-0.063	165	+0.040	1.4	0.8
16060 FB2	160	165	60	160	-0.063	165	+0.040	1.4	0.8
16080 FB2	160	165	80	160	-0.063	165	+0.040	1.4	0.8
160100 FB2	160	165	100	160	-0.063	165	+0.040	1.4	0.8



Gleitlagerbüchsen mit Fettaschen zum Nachschmieren FB2

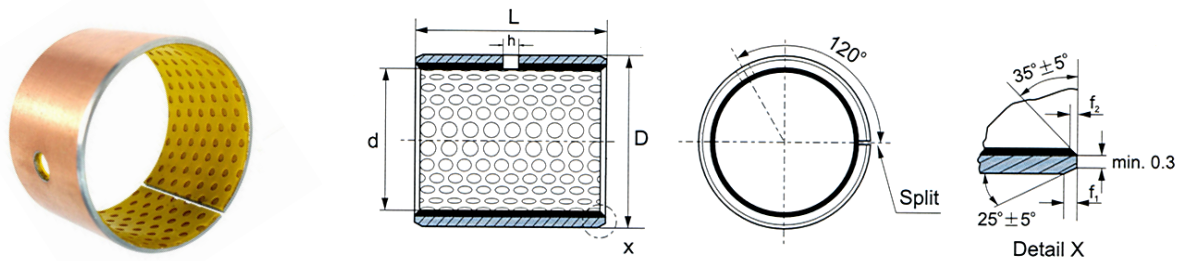

Bezeichnung	d	D	L	Wellendurchmesser		Gehäusebohrung		f1	f2
				Toleranz h8		Toleranz H7			
17050 FB2	170	175	50	170	-0.063	175	+0.040	1.4	0.8
17080 FB2	170	175	80	170	-0.063	175	+0.040	1.4	0.8
170100 FB2	170	175	100	170	-0.063	175	+0.040	1.4	0.8
18050 FB2	180	185	50	180	-0.063	185	+0.046	1.4	0.8
18060 FB2	180	185	60	180	-0.063	185	+0.046	1.4	0.8
18080 FB2	180	185	80	180	-0.063	185	+0.046	1.4	0.8
180100 FB2	180	185	100	180	-0.063	185	+0.046	1.4	0.8
19050 FB2	190	195	50	190	-0.072	195	+0.046	1.4	0.8
19060 FB2	190	195	60	190	-0.072	195	+0.046	1.4	0.8
19080 FB2	190	195	80	190	-0.072	195	+0.046	1.4	0.8
190100 FB2	190	195	100	190	-0.072	195	+0.046	1.4	0.8
190120 FB2	190	195	120	190	-0.072	195	+0.046	1.4	0.8
20050 FB2	200	205	50	200	-0.072	205	+0.046	1.4	0.8
20060 FB2	200	205	60	200	-0.072	205	+0.046	1.4	0.8
20080 FB2	200	205	80	200	-0.072	205	+0.046	1.4	0.8
200100 FB2	200	205	100	200	-0.072	205	+0.046	1.4	0.8
200120 FB2	200	205	120	200	-0.072	205	+0.046	1.4	0.8
22050 FB2	220	225	50	220	-0.072	225	+0.046	1.4	0.8
22060 FB2	220	225	60	220	-0.072	225	+0.046	1.4	0.8
22080 FB2	220	225	80	220	-0.072	225	+0.046	1.4	0.8
220100 FB2	220	225	100	220	-0.072	225	+0.046	1.4	0.8
220120 FB2	220	225	120	220	-0.072	225	+0.046	1.4	0.8
24050 FB2	240	245	50	240	-0.072	245	+0.046	1.4	0.8
24060 FB2	240	245	60	240	-0.072	245	+0.046	1.4	0.8
24080 FB2	240	245	80	240	-0.072	245	+0.046	1.4	0.8
240100 FB2	240	245	100	240	-0.072	245	+0.046	1.4	0.8
240120 FB2	240	245	120	240	-0.072	245	+0.046	1.4	0.8
25050 FB2	250	255	50	250	-0.072	255	+0.052	1.4	0.8
25060 FB2	250	255	60	250	-0.072	255	+0.052	1.4	0.8
25080 FB2	250	255	80	250	-0.072	255	+0.052	1.4	0.8

Gleitlagerbüchsen mit Fettaschen zum Nachschmieren FB2

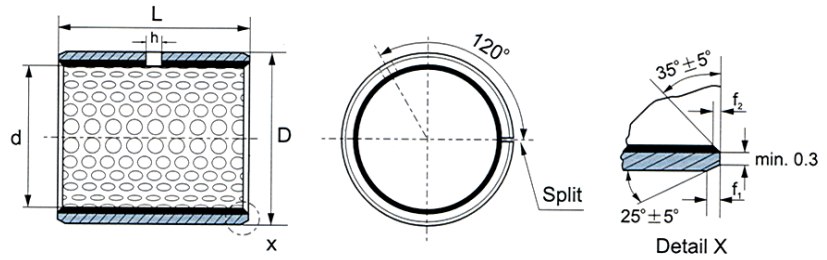
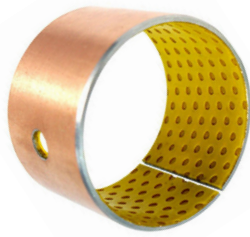

Bezeichnung	d	D	L	Wellendurchmesser		Gehäusebohrung		f1	f2
				Toleranz h8		Toleranz H7			
<b>250100 FB2</b>	250	255	100	250	-0.072	255	+0.052	1.4	0.8
<b>250120 FB2</b>	250	255	120	250	-0.072	255	+0.052	1.4	0.8
<b>26050 FB2</b>	260	265	50	260	-0.081	265	+0.052	1.4	0.8
<b>26060 FB2</b>	260	265	60	260	-0.081	265	+0.052	1.4	0.8
<b>26080 FB2</b>	260	265	80	260	-0.081	265	+0.052	1.4	0.8
<b>260100 FB2</b>	260	265	100	260	-0.081	265	+0.052	1.4	0.8
<b>260120 FB2</b>	260	265	120	260	-0.081	265	+0.052	1.4	0.8
<b>28050 FB2</b>	280	285	50	280	-0.081	285	+0.052	1.4	0.8
<b>28060 FB2</b>	280	285	60	280	-0.081	285	+0.052	1.4	0.8
<b>28080 FB2</b>	280	285	80	280	-0.081	285	+0.052	1.4	0.8
<b>280100 FB2</b>	280	285	100	280	-0.081	285	+0.052	1.4	0.8
<b>280120 FB2</b>	280	285	120	280	-0.081	285	+0.052	1.4	0.8
<b>30050 FB2</b>	300	305	50	300	-0.081	305	+0.052	1.4	0.8
<b>30060 FB2</b>	300	305	60	300	-0.081	305	+0.052	1.4	0.8
<b>30080 FB2</b>	300	305	80	300	-0.081	305	+0.052	1.4	0.8
<b>300100 FB2</b>	300	305	100	300	-0.081	305	+0.052	1.4	0.8
<b>300120 FB2</b>	300	305	120	300	-0.081	305	+0.052	1.4	0.8

## Gleitlagerbüchsen in verschiedenen Kompositionen



FB11 chemisch- und korrosionsbeständige Ausführung mit Bronze Rücken



FB 30 INOX Ausführung

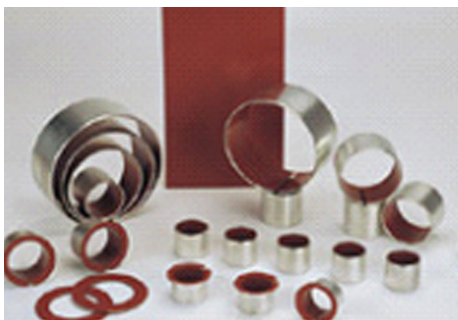

FB 40 Ausführung für Hydraulikanwendungen

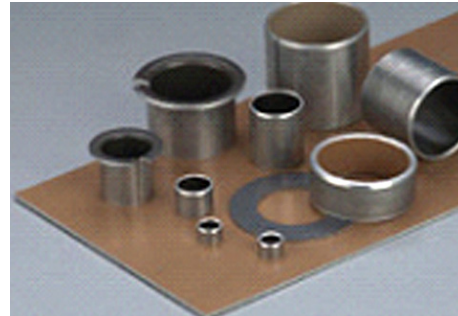

FBLA10 - FB10DH neue Materialien mit höherer Belastbarkeit und verbesserten Gleiteigenschaften



FB90 Sinterbronze mit Bronze-Rücken

### Herausgeber und Gestaltung: MTO & Co AG

### Copyright © MTO & Co AG

Nachdruck, auch auszugsweise, bei Quellenangabe und Zusendung eines Belegexemplars nur nach Absprache mit MTO & Co. gestattet. Die Angaben in dieser Technischen Schrift basieren auf unseren allgemeinen Erfahrungen und Kenntnissen bei Drucklegung und sollen dem technisch erfahrenen Leser Hinweise für mögliche Anwendungen geben. Die Produktinformationen beinhalten jedoch keine Zusicherung von Eigenschaften oder Garantie der Eignung des Produkts für den Einzelfall. Sie entbinden den Anwender nicht davon, die Anwendung des ausgewählten Produkts vorher im Versuch zu testen. Wir empfehlen ein individuelles Beratungsgespräch und stellen auf Wunsch und nach Möglichkeit auch gerne Muster für Tests zur Verfügung. MTO Produkte werden kontinuierlich weiterentwickelt. Deshalb behält sich MTO & CO. AG das recht vor, alle technischen Daten in dieser Druckschrift jederzeit und ohne Vorankündigung zu ändern.

**FÜR TECHNISCH  
OPTIMALE UND  
WIRTSCHAFTLICHE  
LÖSUNGEN.**

**MINIATURLAGER**

**KUGEL- UND ROLLENLAGER**

**GEHÄUSELAGER**

**GELENKLAGER UND GELENKKÖPFE**

**LINEARTECHNIK**

**GLEITLAGER**

**DICHTUNGEN**

**KUGELN, ROLLEN, NADELN**



**HIGH TECHNOLOGY FOR PROFESSIONALS**

**HAUPTSITZ  
SCHWEIZ  
MTO & CO. AG**

Grabenstrasse 9  
CH-7324 Vilters  
T. +41 81 300 40 00  
[www.mtoswiss.ch](http://www.mtoswiss.ch)  
[info@mtoswiss.ch](mailto:info@mtoswiss.ch)

**NIEDERLASSUNG  
ÖSTERREICH  
MTO UNION GMBH**

Münkafeld 7b  
A-6800 Feldkirch  
T. +43 55 223 78 26  
[www.mtoeurope.com](http://www.mtoeurope.com)  
[info@mtoeurope.com](mailto:info@mtoeurope.com)